

DISCRAFT ULTIMATE OPEN 2026~OPEN DIV.~  
Qualifying tournament

Tournament A

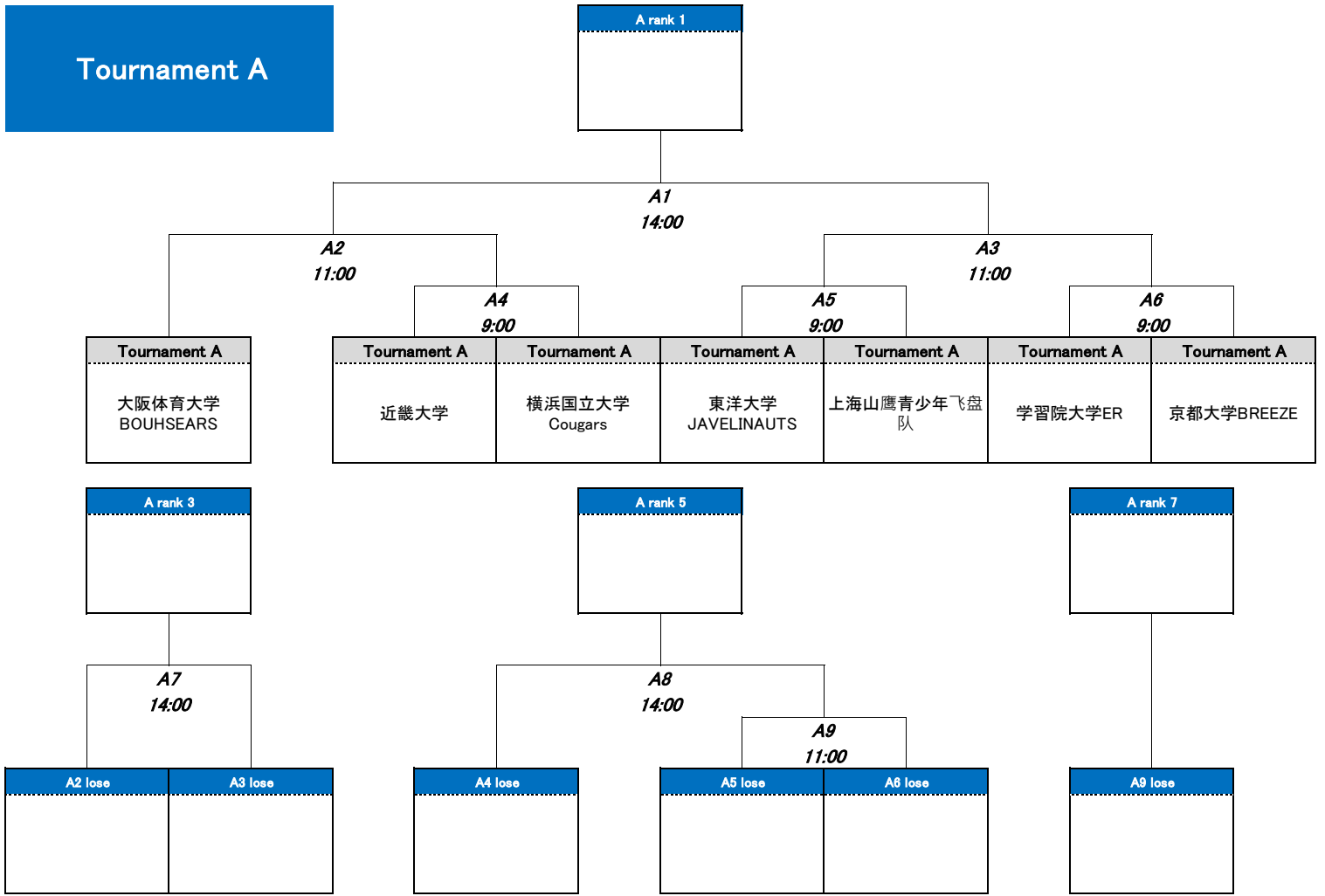

Tournament B

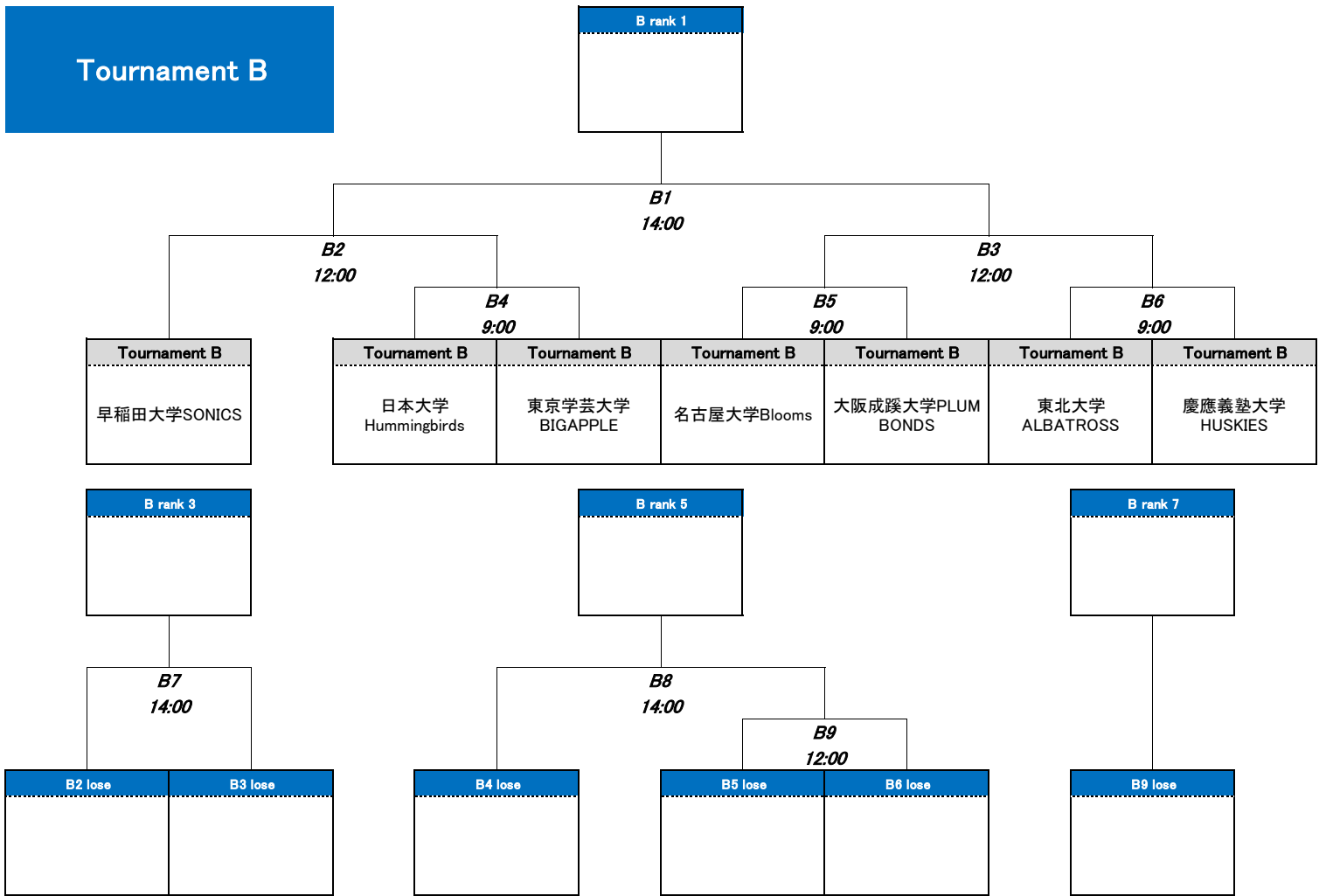

DISCRAFT ULTIMATE OPEN 2026~OPEN DIV.~  
Qualifying tournament

Tournament C

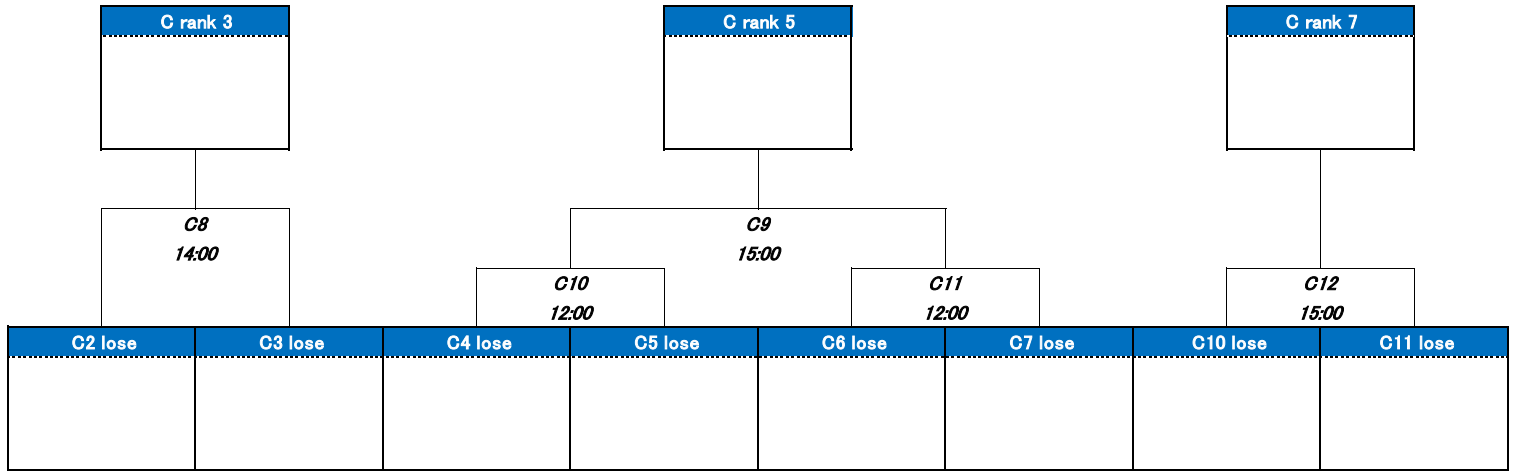
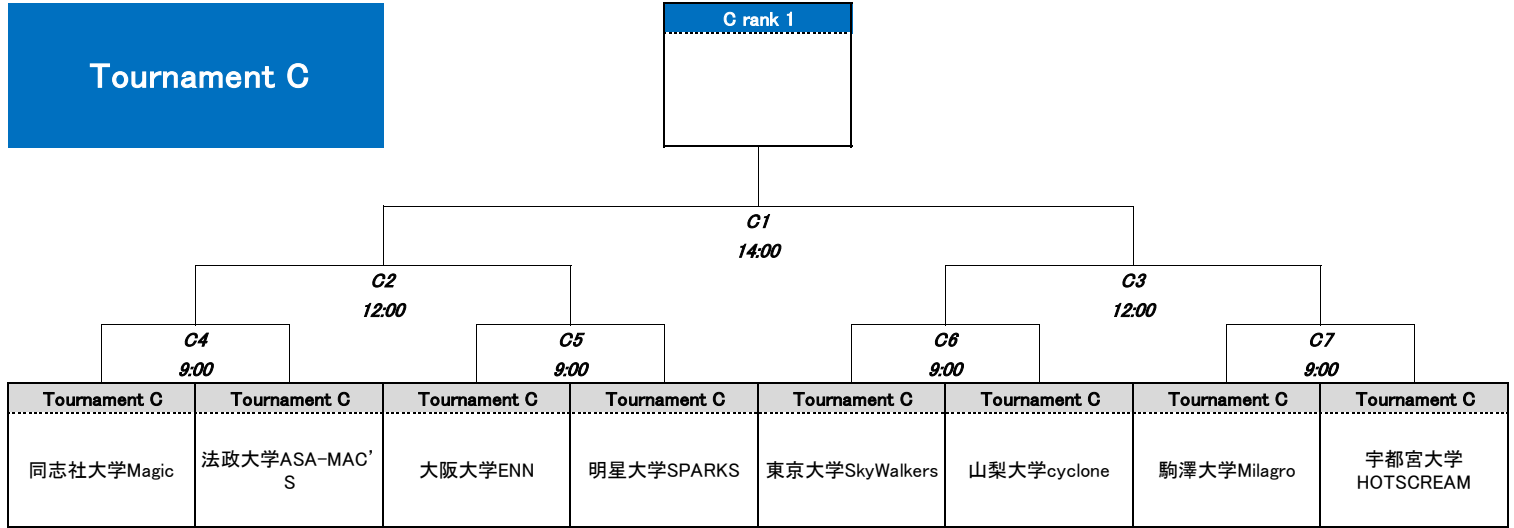

Tournament D

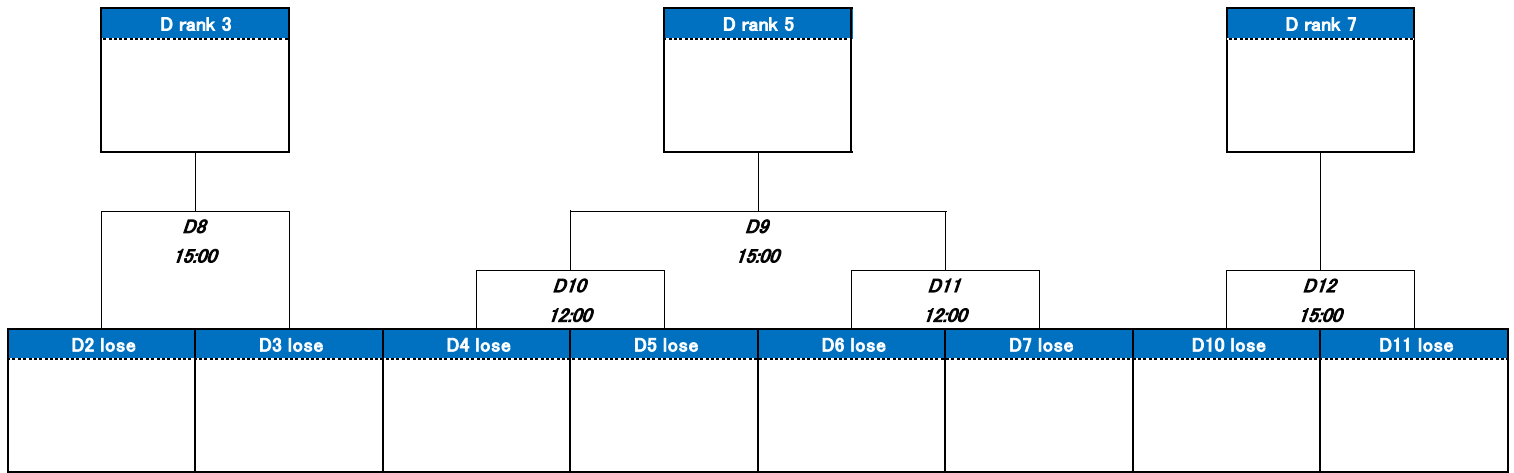
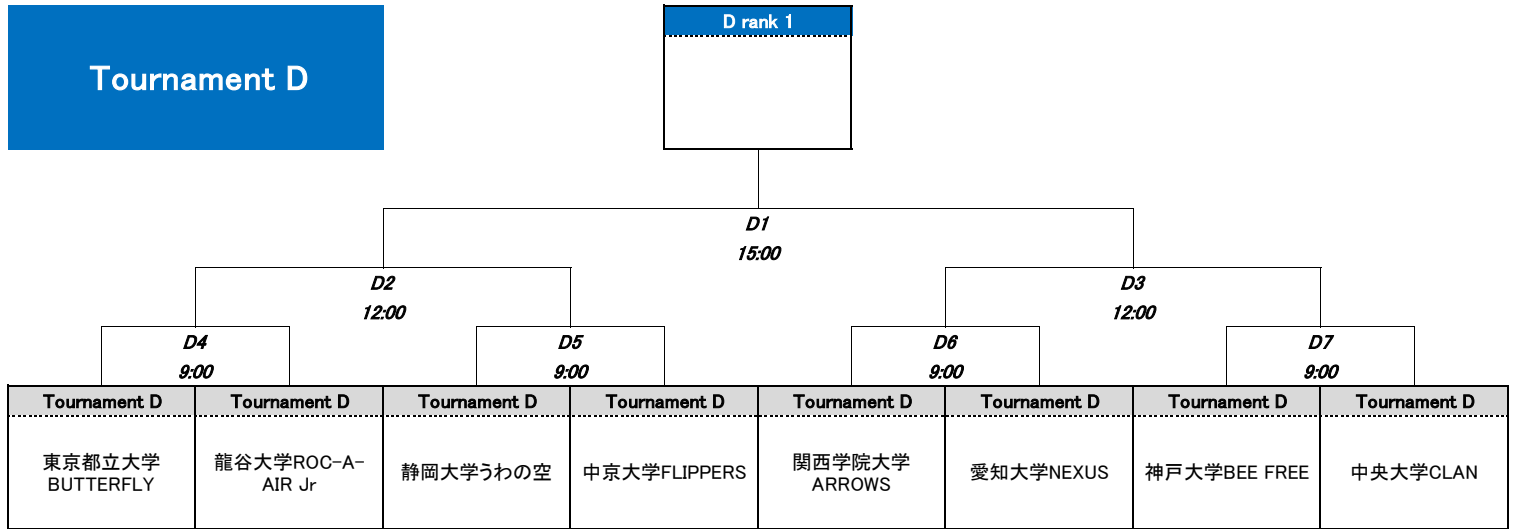



DISCRAFT ULTIMATE OPEN 2026~OPEN DIV.~  
Qualifying tournament

Tournament G

G rank 1

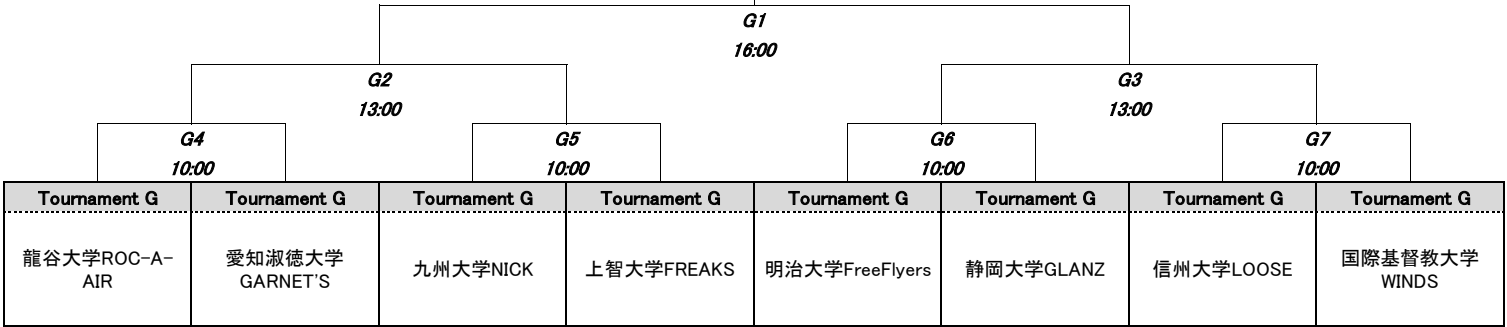

G rank 3

G rank 5

G rank 7

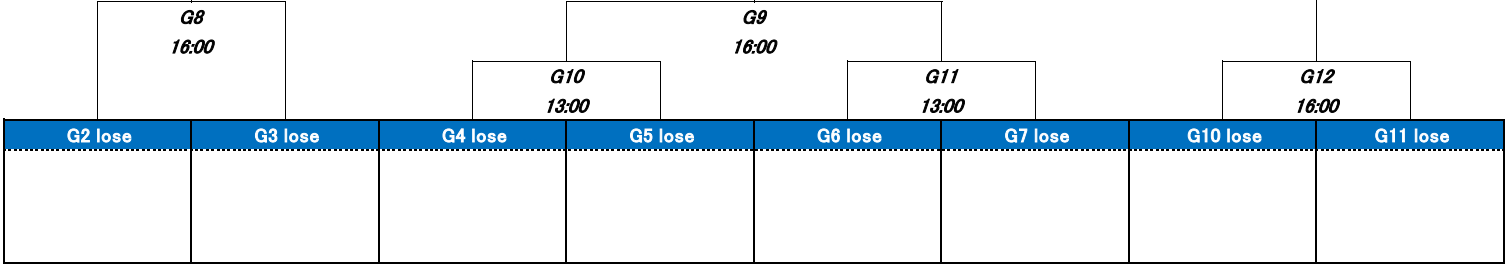

# DISCRAFT ULTIMATE OPEN 2026~OPEN DIV.~

## Qualifying tournament ranking

Tournament rank		TEAM NAME	NEXT
Tournament A	1		1st placem ent tourna ment
Tournament B			
Tournament C			
Tournament D			
Tournament E			
Tournament F			
Tournament G			
Tournament A	2		9th placem ent tourna ment
Tournament B			
Tournament C			
Tournament D			
Tournament E			
Tournament F			
Tournament G			
Tournament A	3		17th placem ent tourna ment
Tournament B			
Tournament C			
Tournament D			
Tournament E			
Tournament F			
Tournament G			
Tournament A	4		25th placem ent tourna ment
Tournament B			
Tournament C			
Tournament D			
Tournament E			
Tournament F			
Tournament G			
Tournament A	5		33rd placem ent tourna ment
Tournament B			
Tournament C			
Tournament D			
Tournament E			
Tournament F			
Tournament G			
Tournament A	6		41st placem ent tourna ment
Tournament B			
Tournament C			
Tournament D			
Tournament E			
Tournament F			
Tournament G			
Tournament A	7		48th placem ent tourna ment
Tournament B			
Tournament C			
Tournament D			
Tournament E			
Tournament F			
Tournament G			
Tournament C	8		48th placem ent tourna ment
Tournament D			
Tournament E			
Tournament F			
Tournament G			

DISCRAFT ULTIMATE OPEN 2026~OPEN DIV.~  
Qualifying tournament

1st placement  
tournament

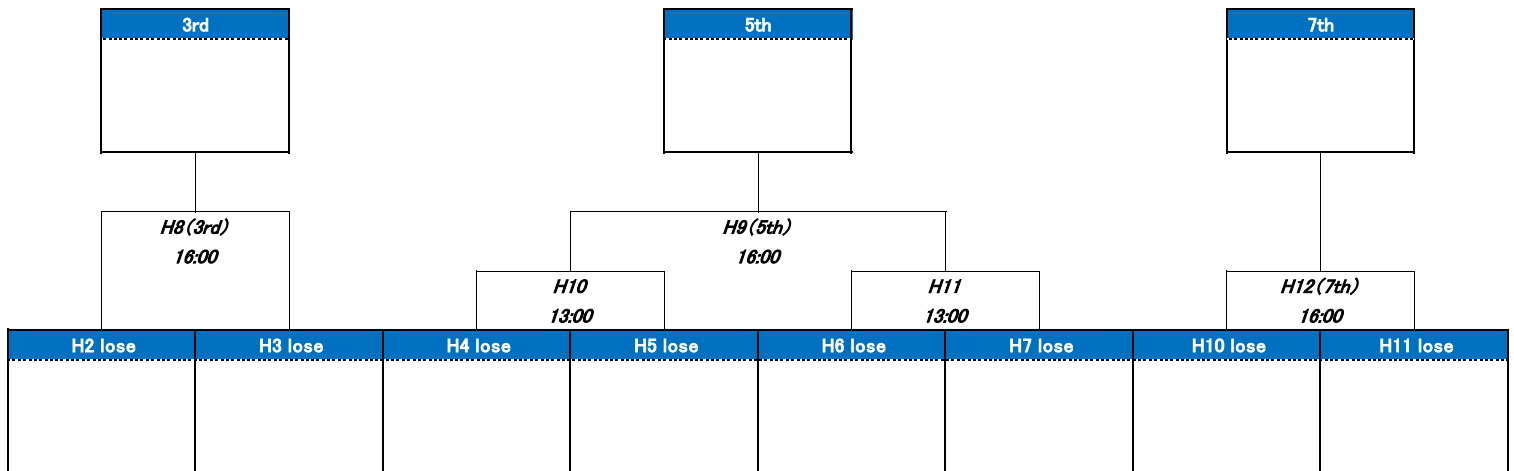
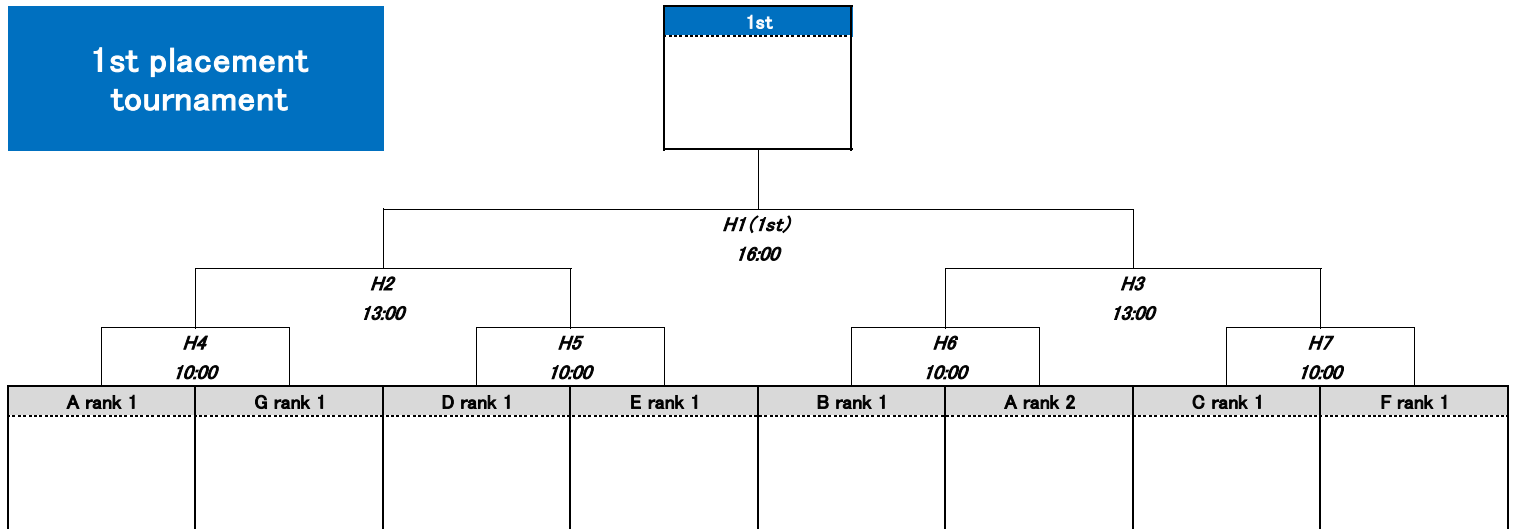

9th placement  
tournament

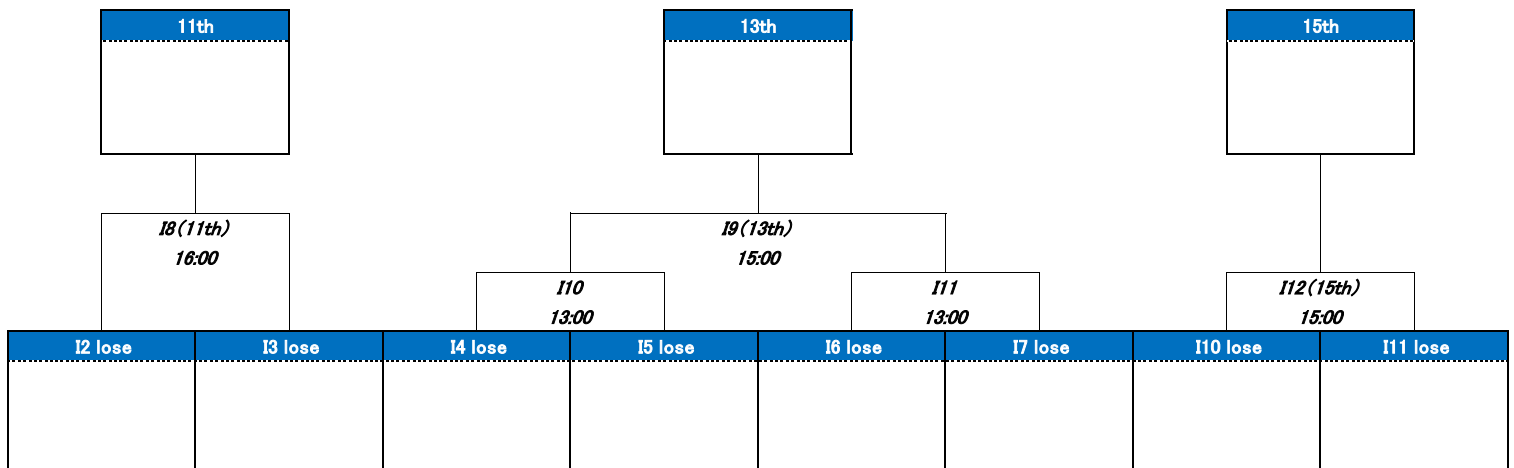
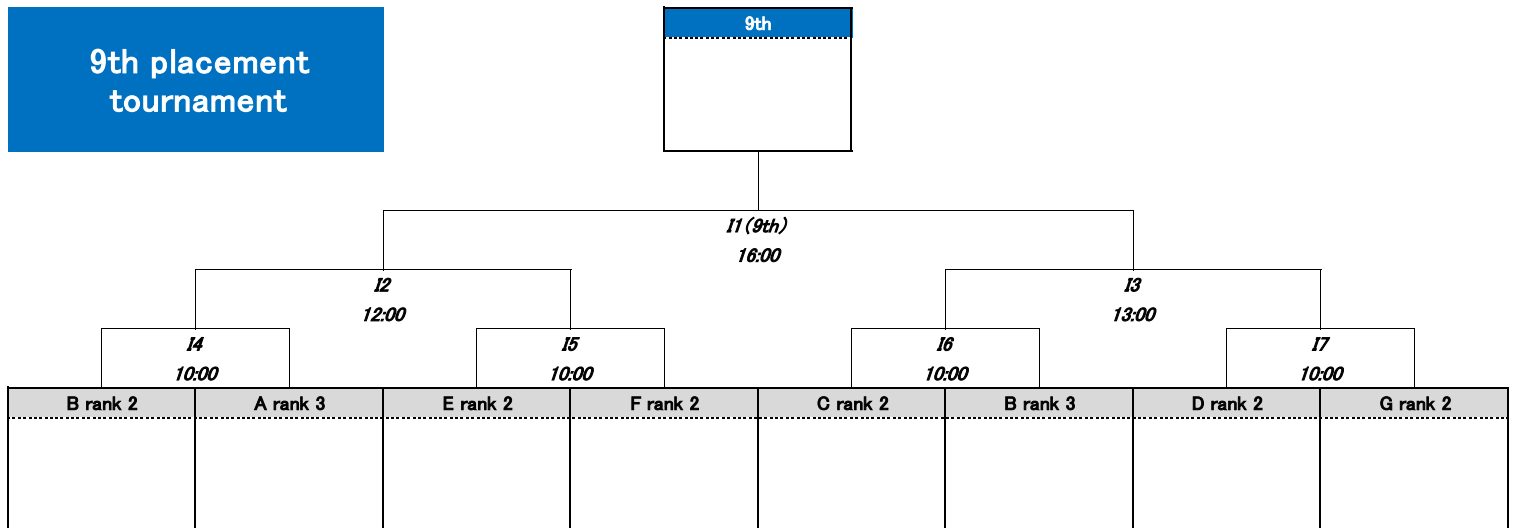

DISCRAFT ULTIMATE OPEN 2026~OPEN DIV.~  
Qualifying tournament

17th placement  
tournament

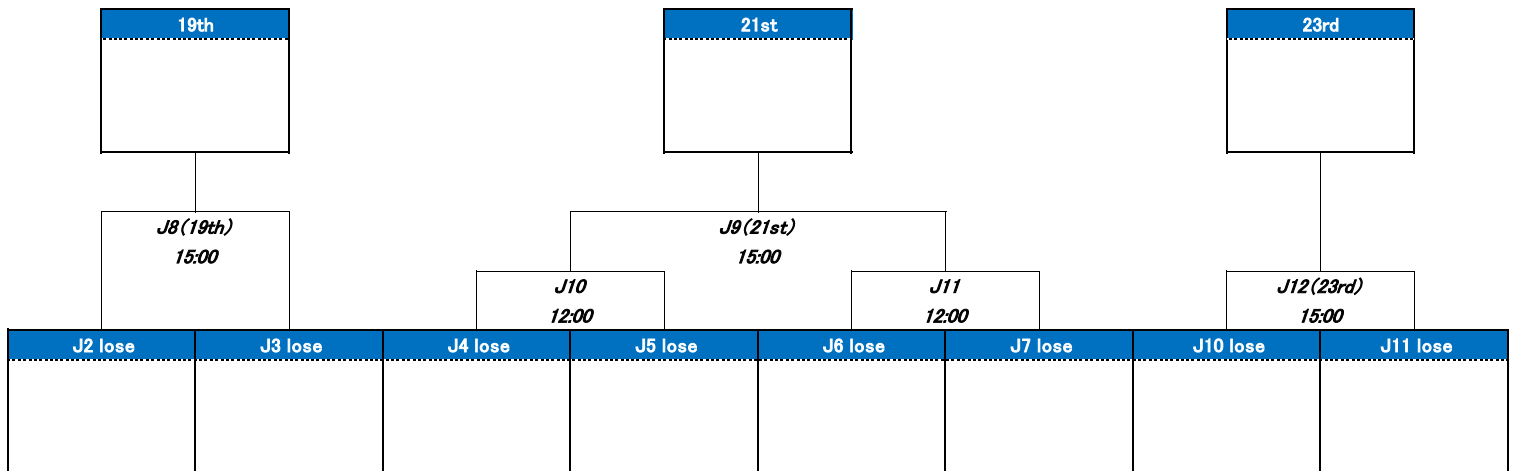
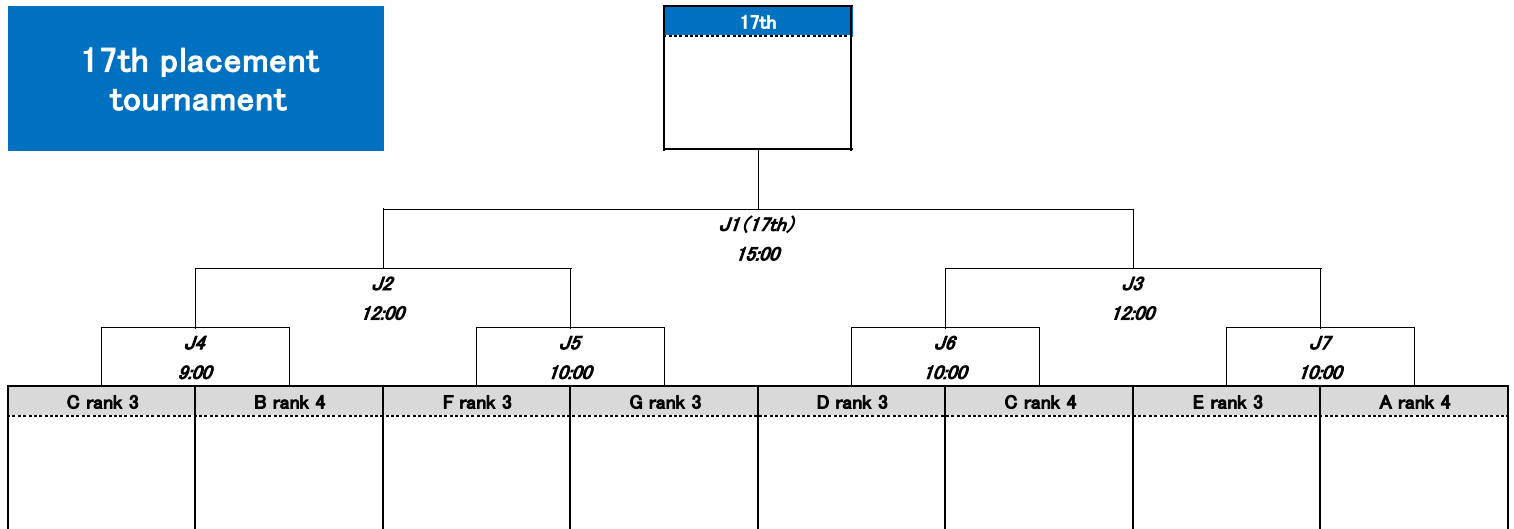

25th placement  
tournament

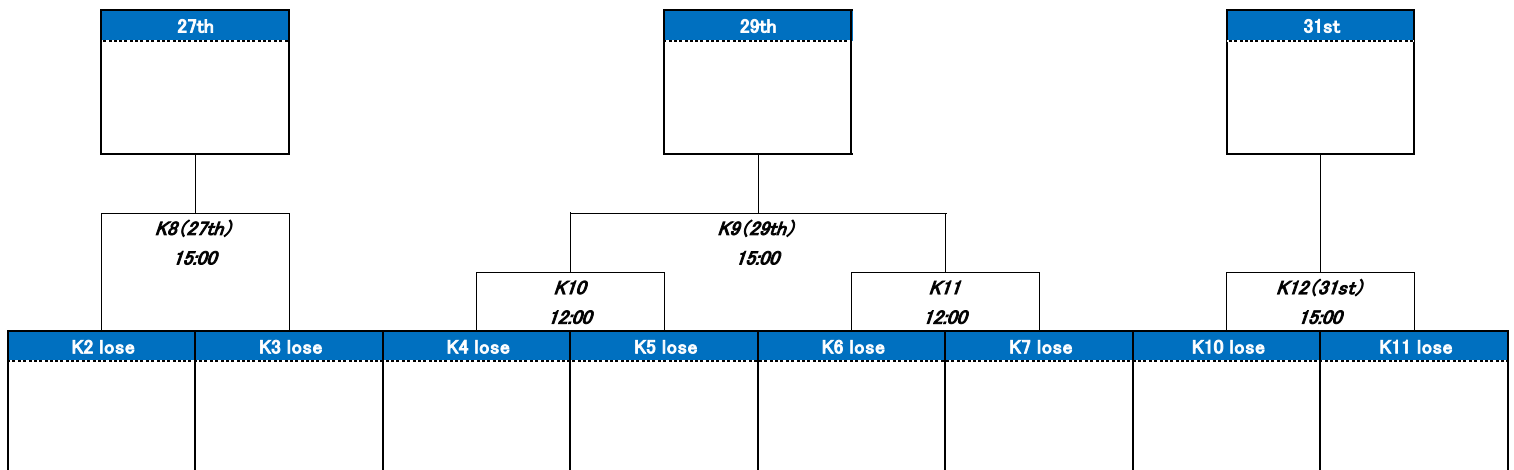
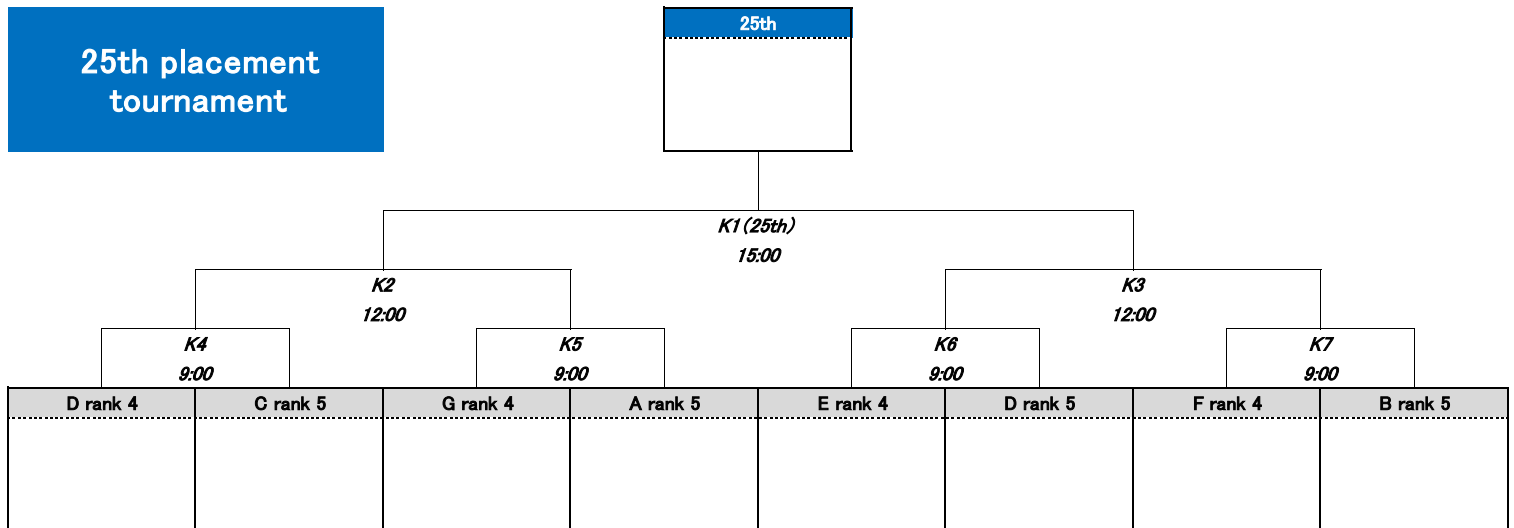

**DISCRAFT ULTIMATE OPEN 2026~OPEN DIV.~**  
Qualifying tournament

**33rd placement tournament**

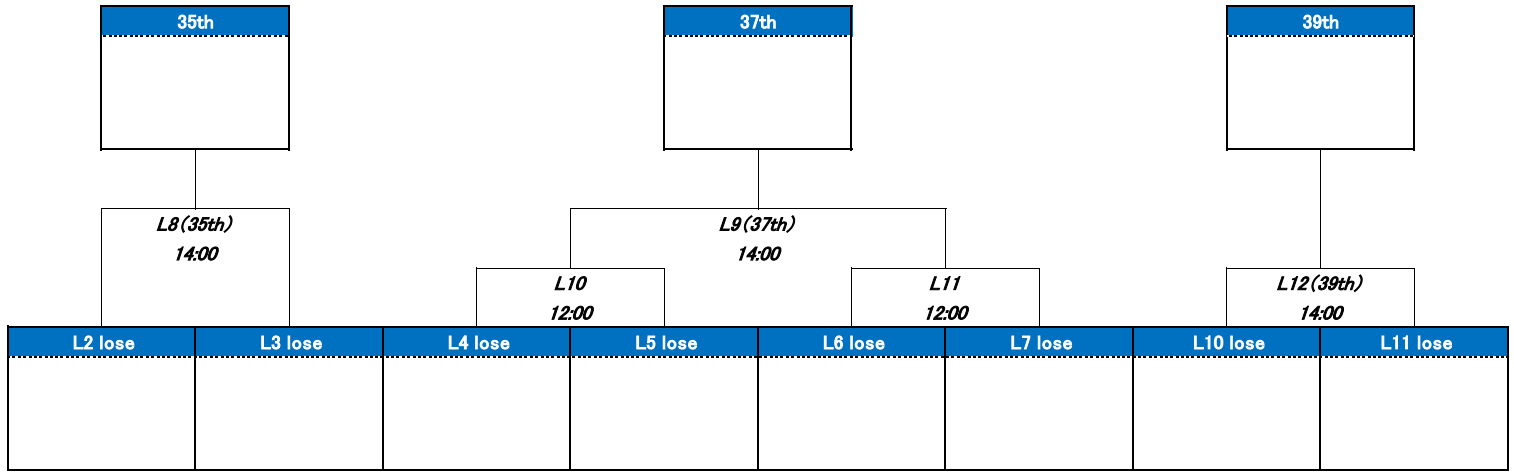
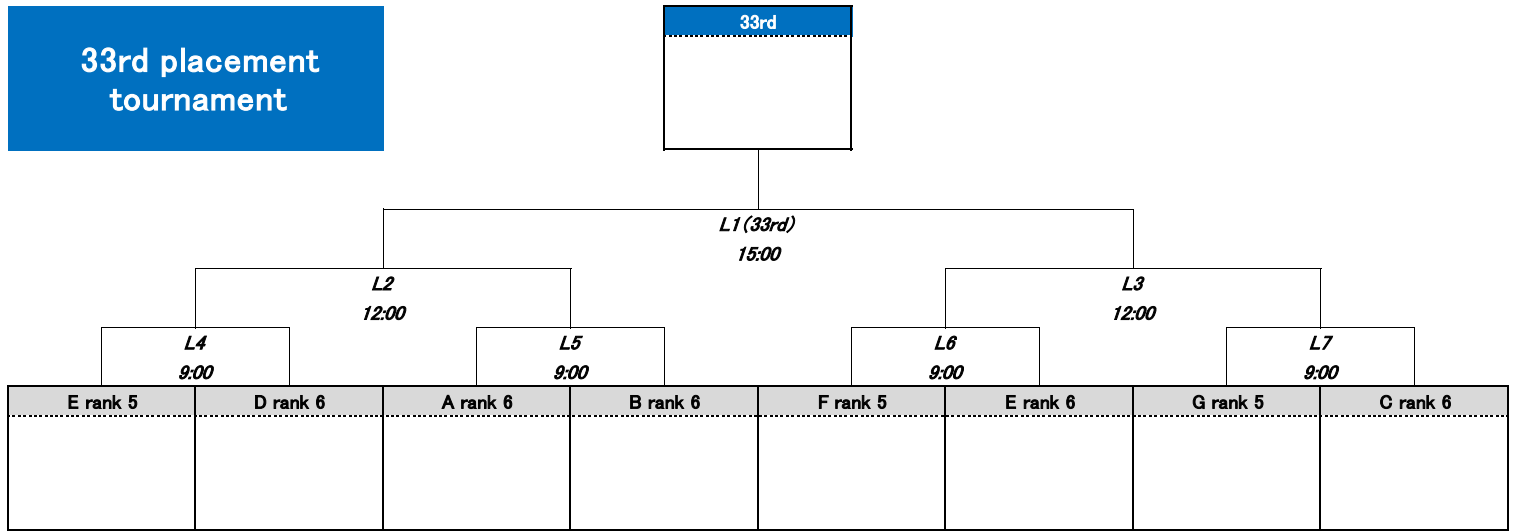

**41st placement tournament**

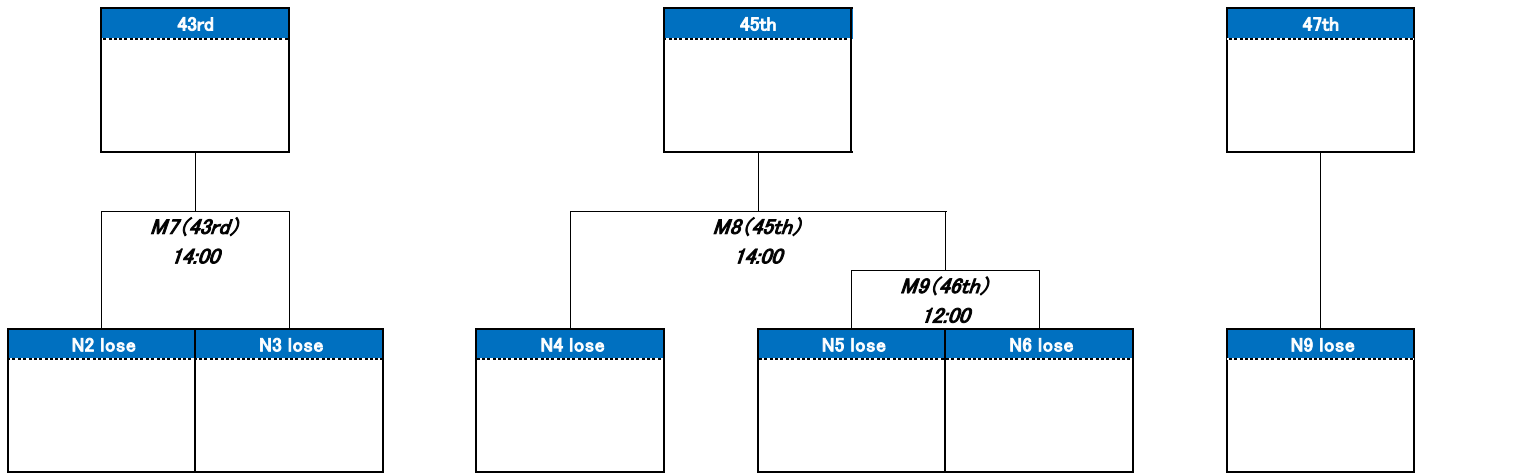
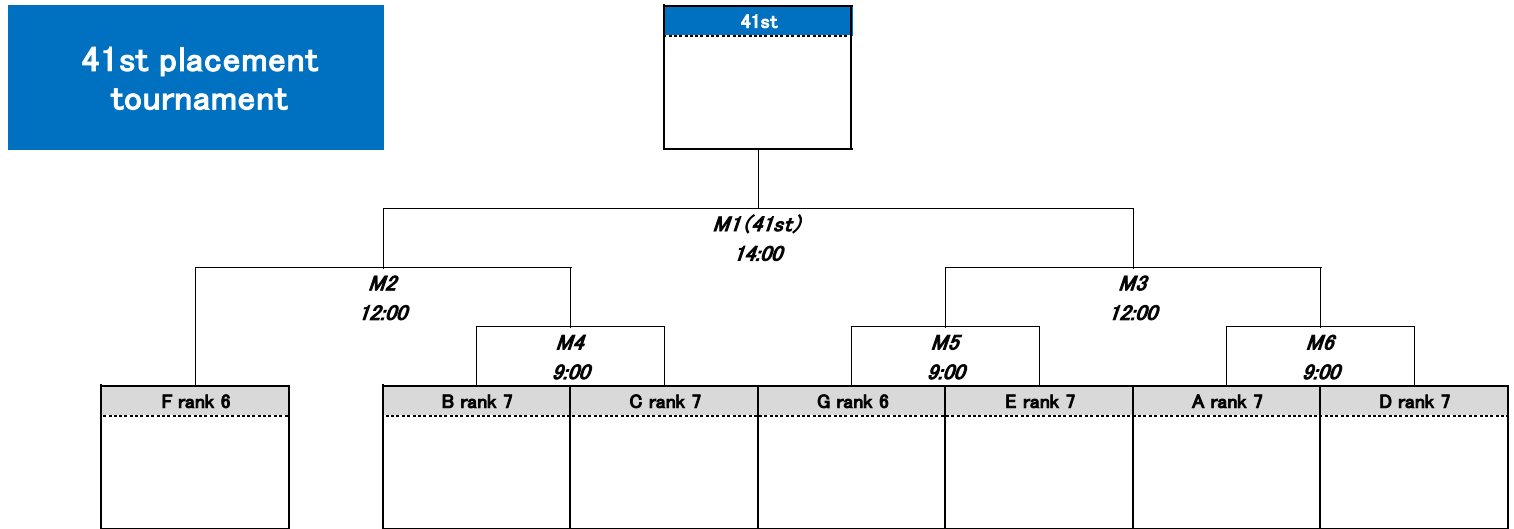

48th placement  
tournament

48th

*N1 (48th)*  
14:00

*N2*  
11:00

*N4*  
9:00

*N5*  
9:00

*N3*  
11:00

*N6*  
9:00

F rank 7

D rank 8	G rank 8	G rank 7	F rank 8	C rank 8	E rank 8

50th

52nd

54th

*N7 (50th)*  
14:00

*N8 (52nd)*  
14:00

*N9 (53rd)*  
11:00

N2 lose
N3 lose

N4 lose

N5 lose
N6 lose

N9 lose

DISCRAFT ULTIMATE OPEN 2026~WOMEN'S DIV.~  
Qualifying tournament

Tournament O

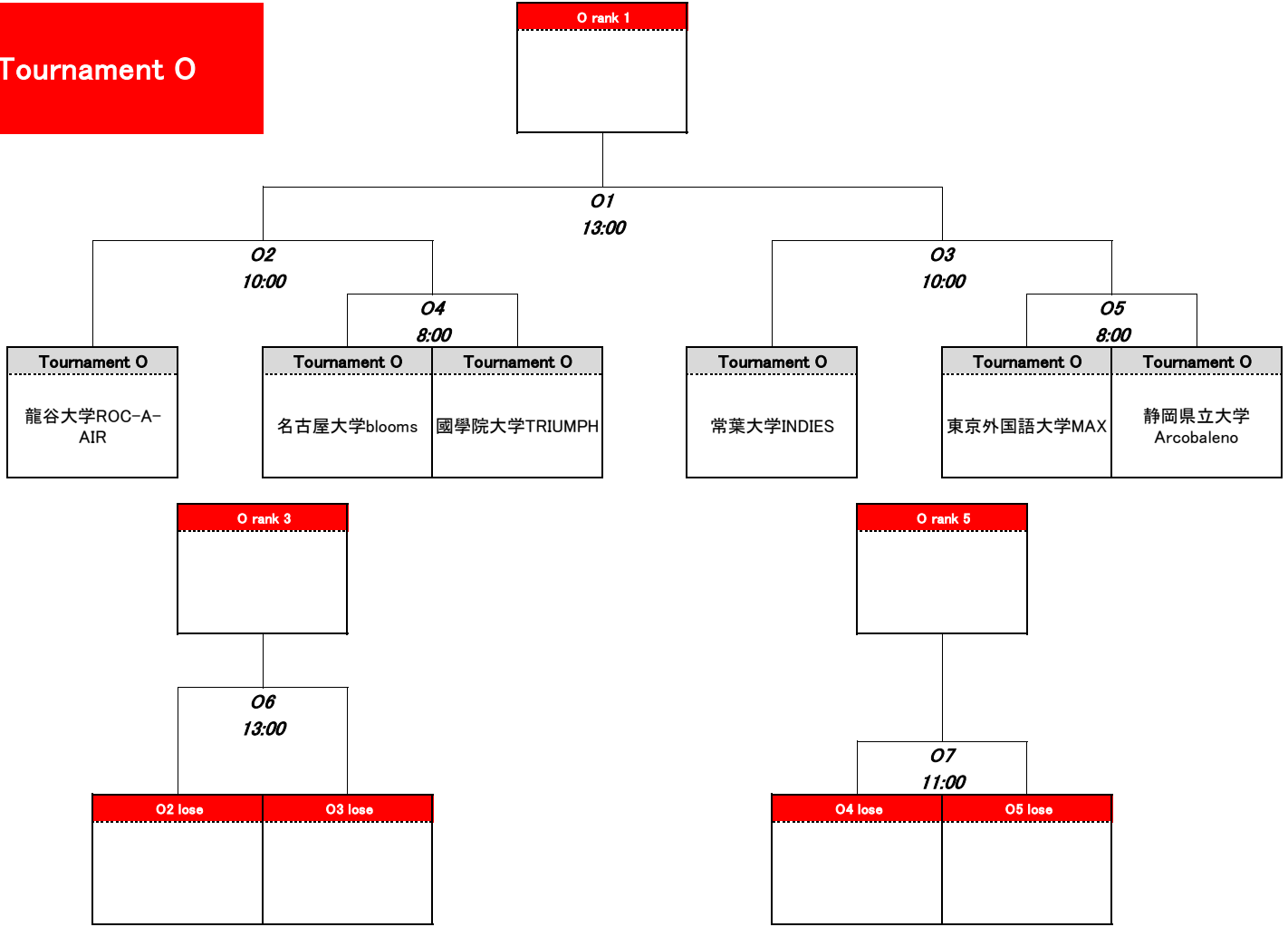

Tournament P

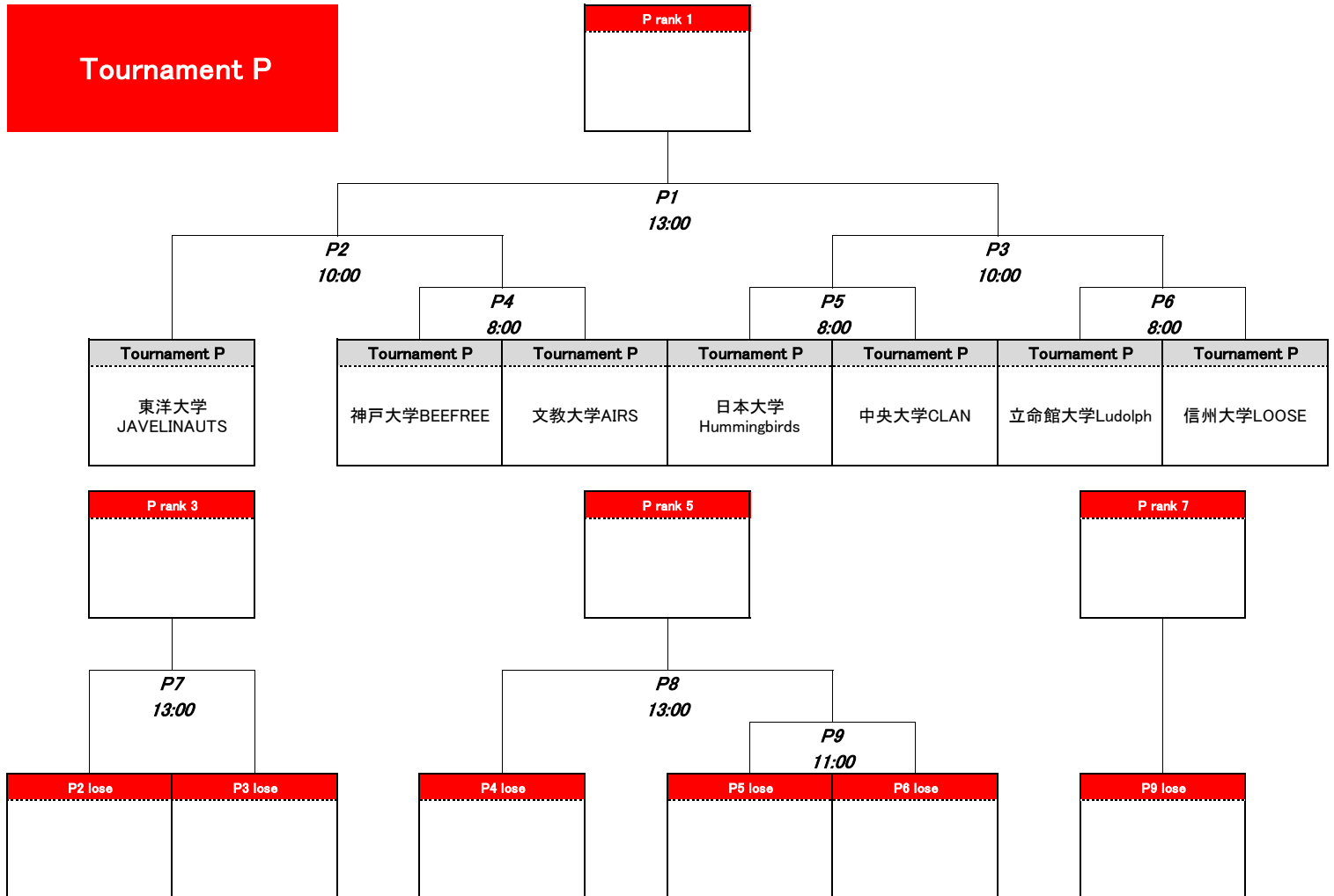

DISCRAFT ULTIMATE OPEN 2026~WOMEN'S DIV.~  
Qualifying tournament

**Tournament Q**

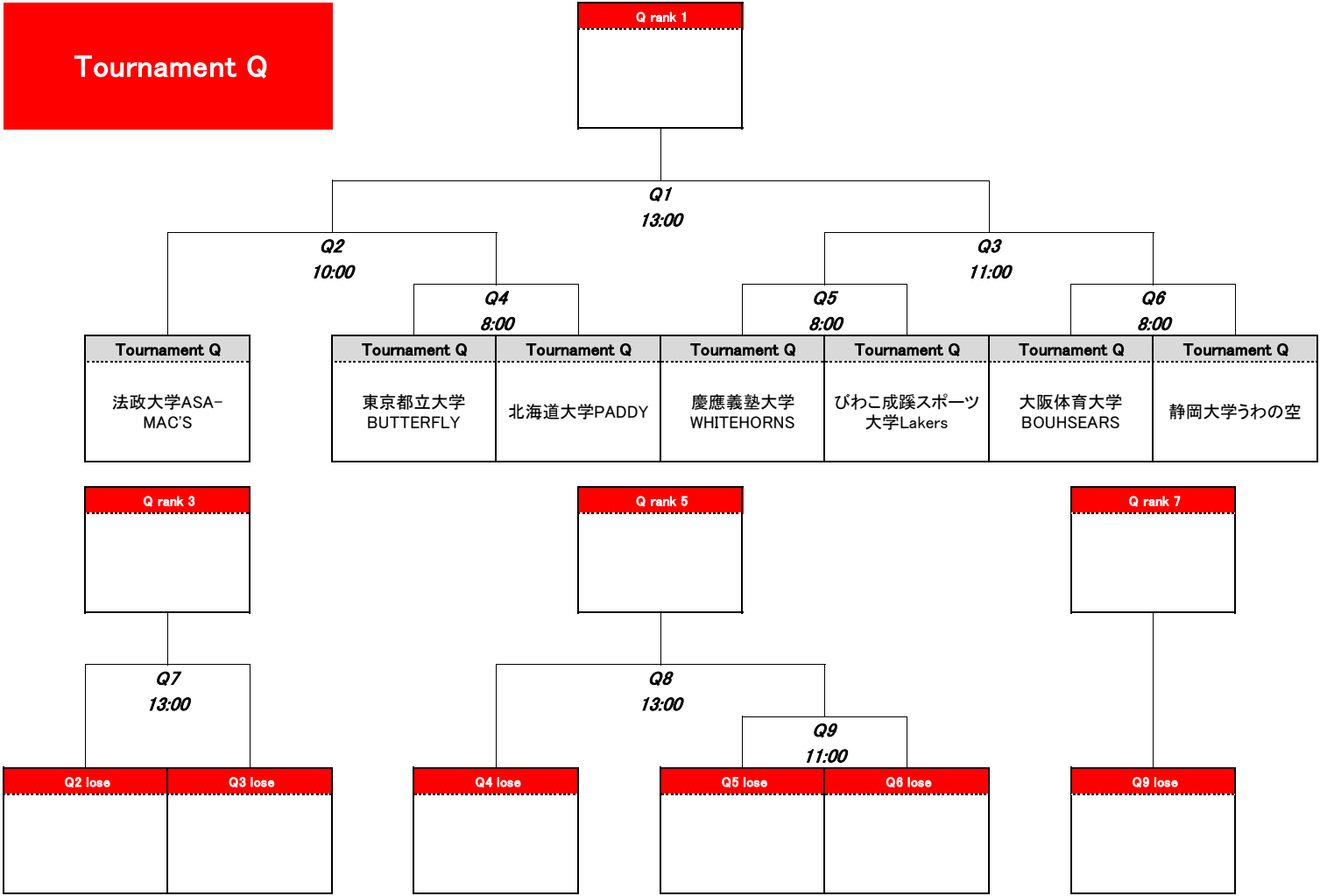

**Tournament R**

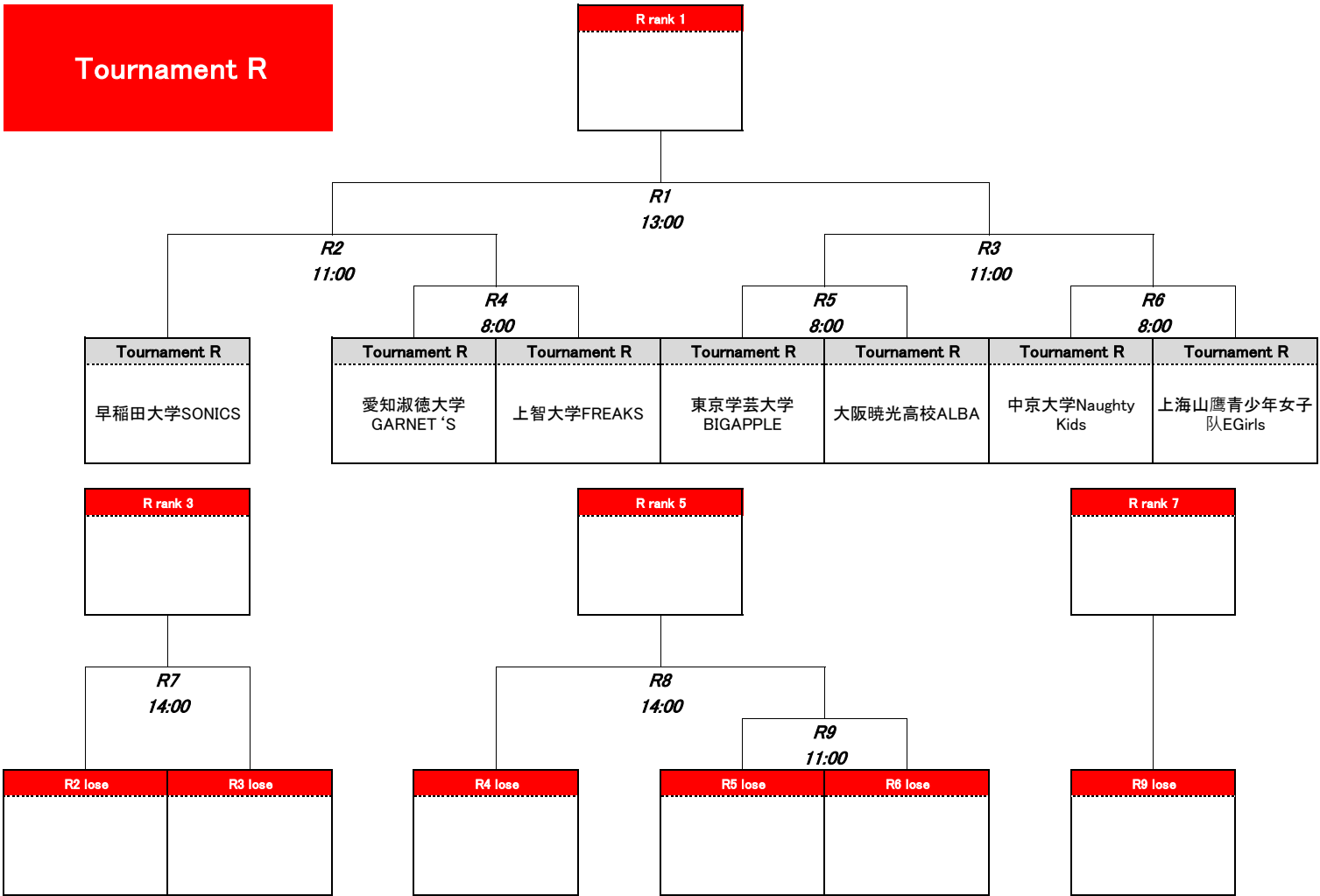

DISCRAFT ULTIMATE OPEN 2026~WOMEN'S DIV.~  
Qualifying tournament

Tournament S

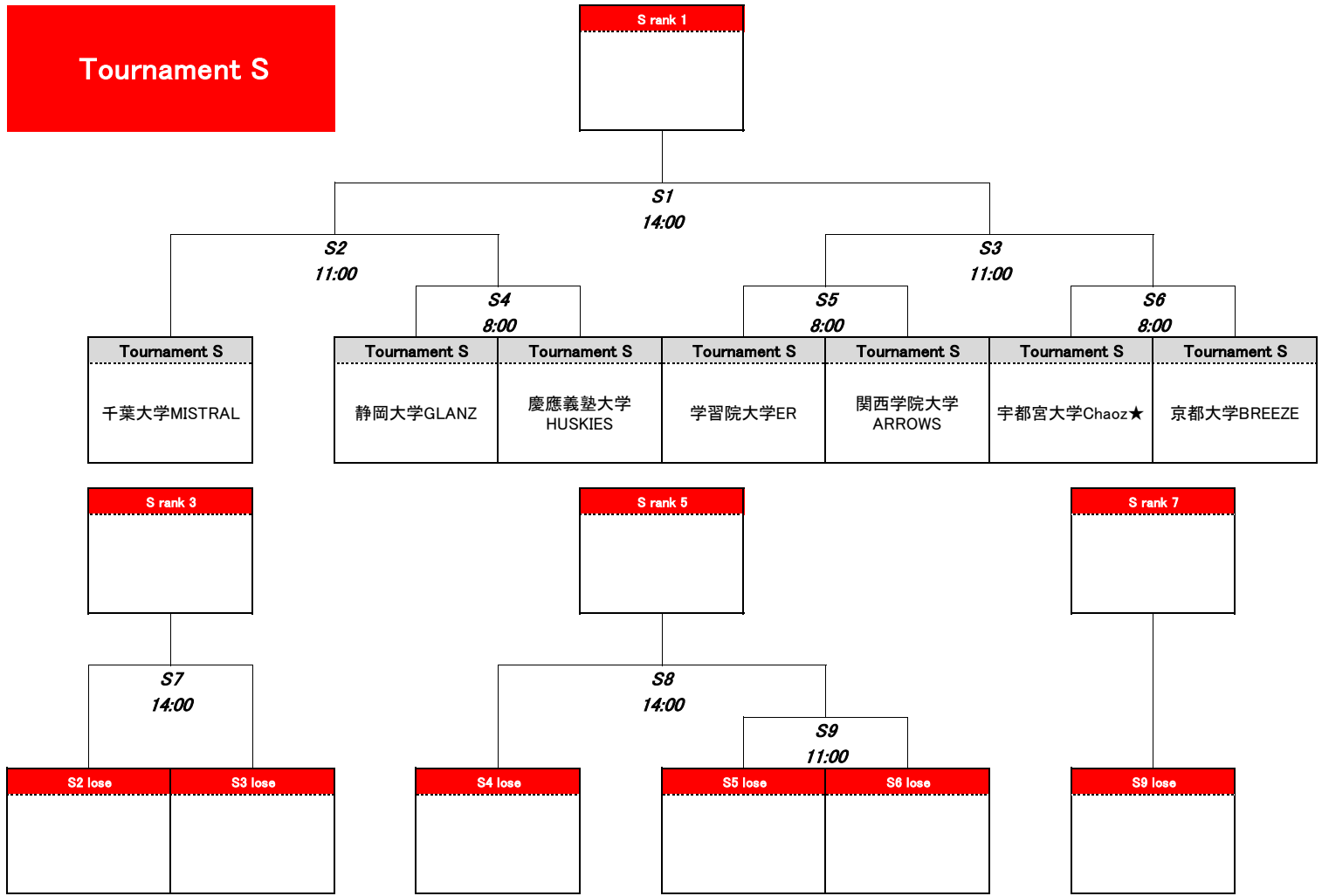

Tournament T

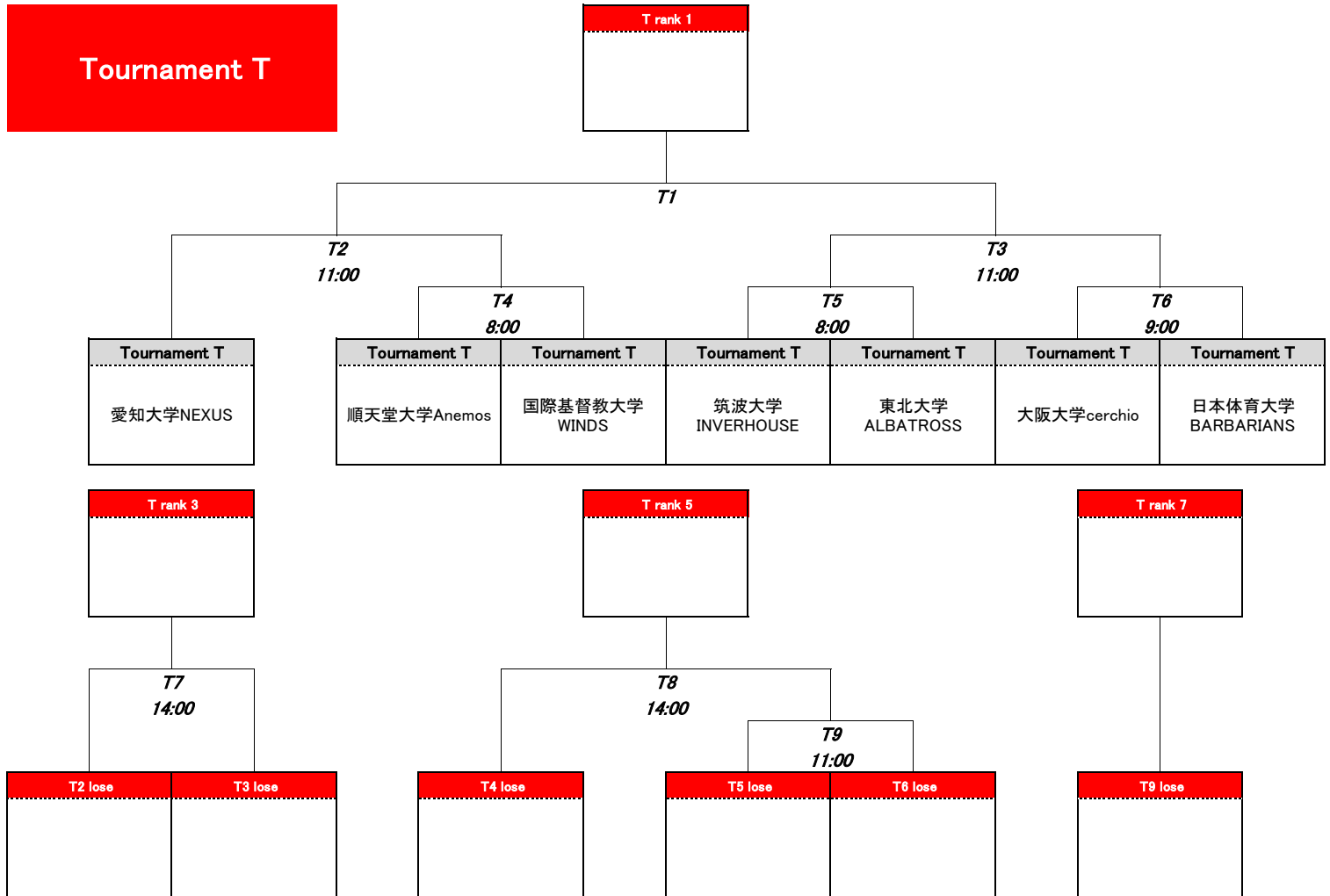

# DISCRAFT ULTIMATE OPEN 2026 ~WOMEN'S DIV.~

## Qualifying tournament ranking

Tournament rank		TEAM NAME	NEXT
Tournament O	1		1st placeme nt tournam ent
Tournament P			
Tournament Q			
Tournament R			
Tournament S			
Tournament T			
Tournament O	2		8th placeme nt tournam ent
Tournament P			
Tournament Q			
Tournament R			
Tournament S			
Tournament T			
Tournament O	3		15th placeme nt tournam ent
Tournament P			
Tournament Q			
Tournament R			
Tournament S			
Tournament T			
Tournament O	4		22nd placeme nt tournam ent
Tournament P			
Tournament Q			
Tournament R			
Tournament S			
Tournament T			
Tournament O	5		29th placeme nt tournam ent
Tournament P			
Tournament Q			
Tournament R			
Tournament S			
Tournament T			
Tournament O	6		36th placeme nt tournam ent
Tournament P			
Tournament Q			
Tournament R			
Tournament S			
Tournament T			
Tournament P			36th placeme nt tournam ent
Tournament Q			
Tournament R			
Tournament S			
Tournament T			

1st placement  
tournament

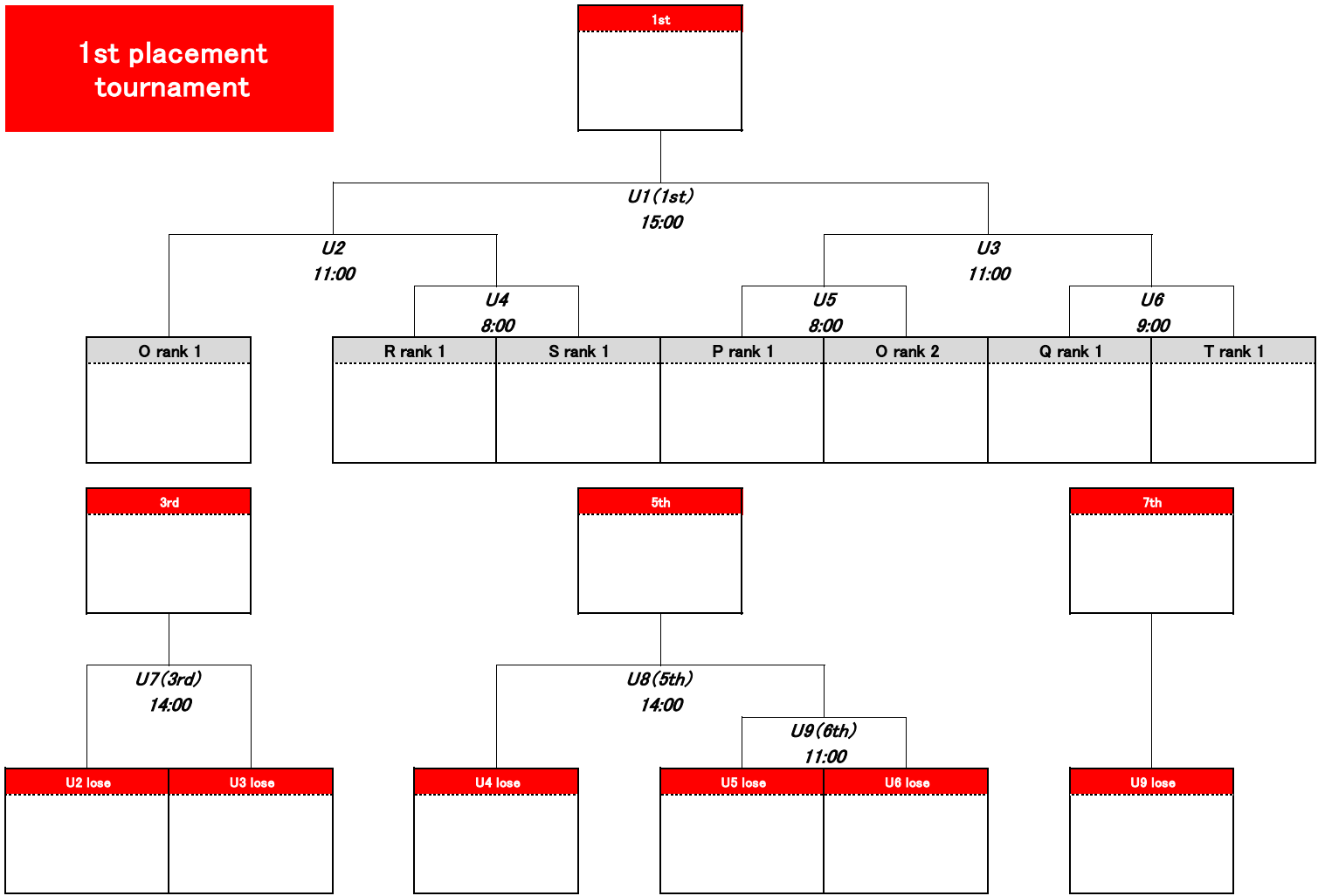

8th placement  
tournament

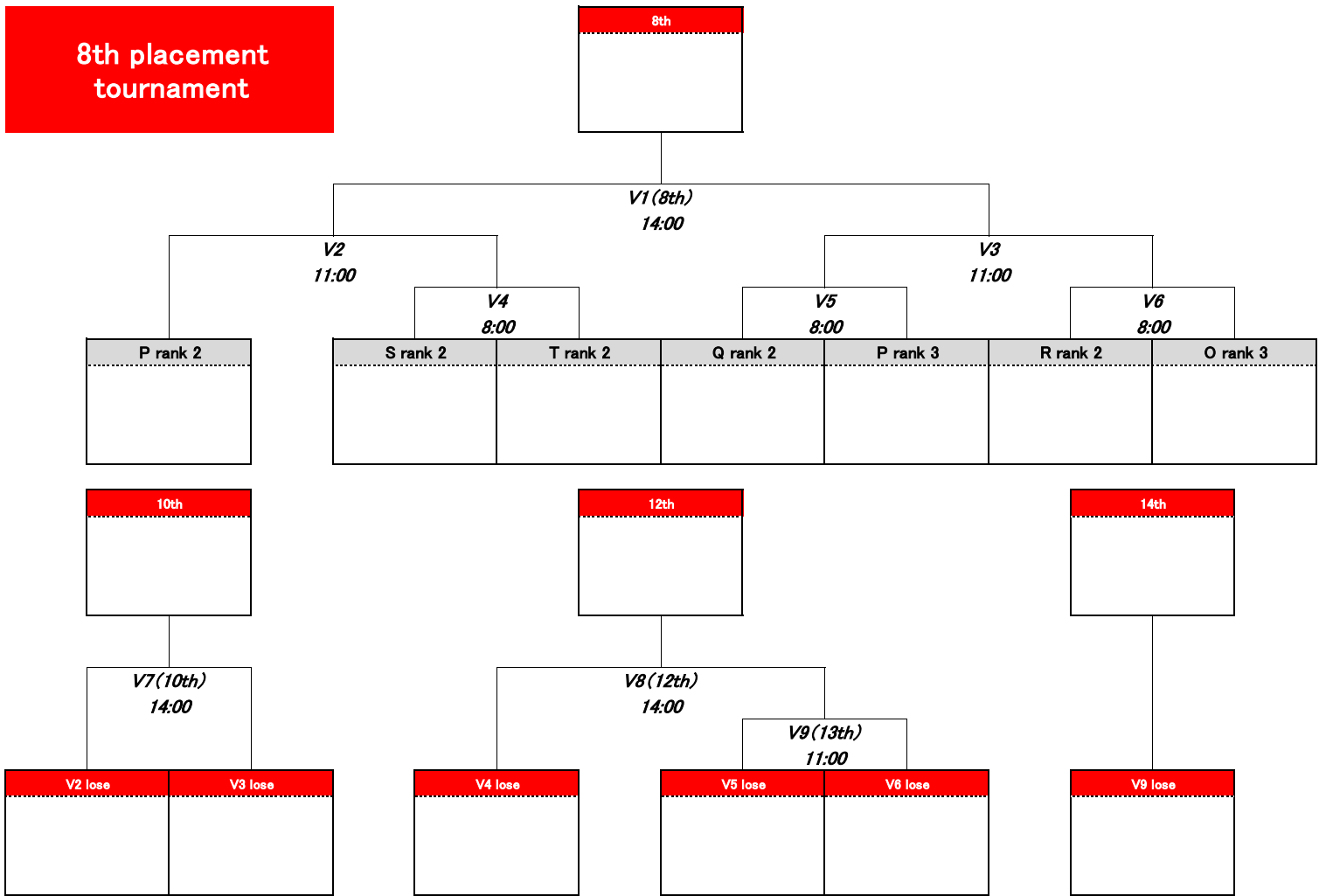

15th placement tournament

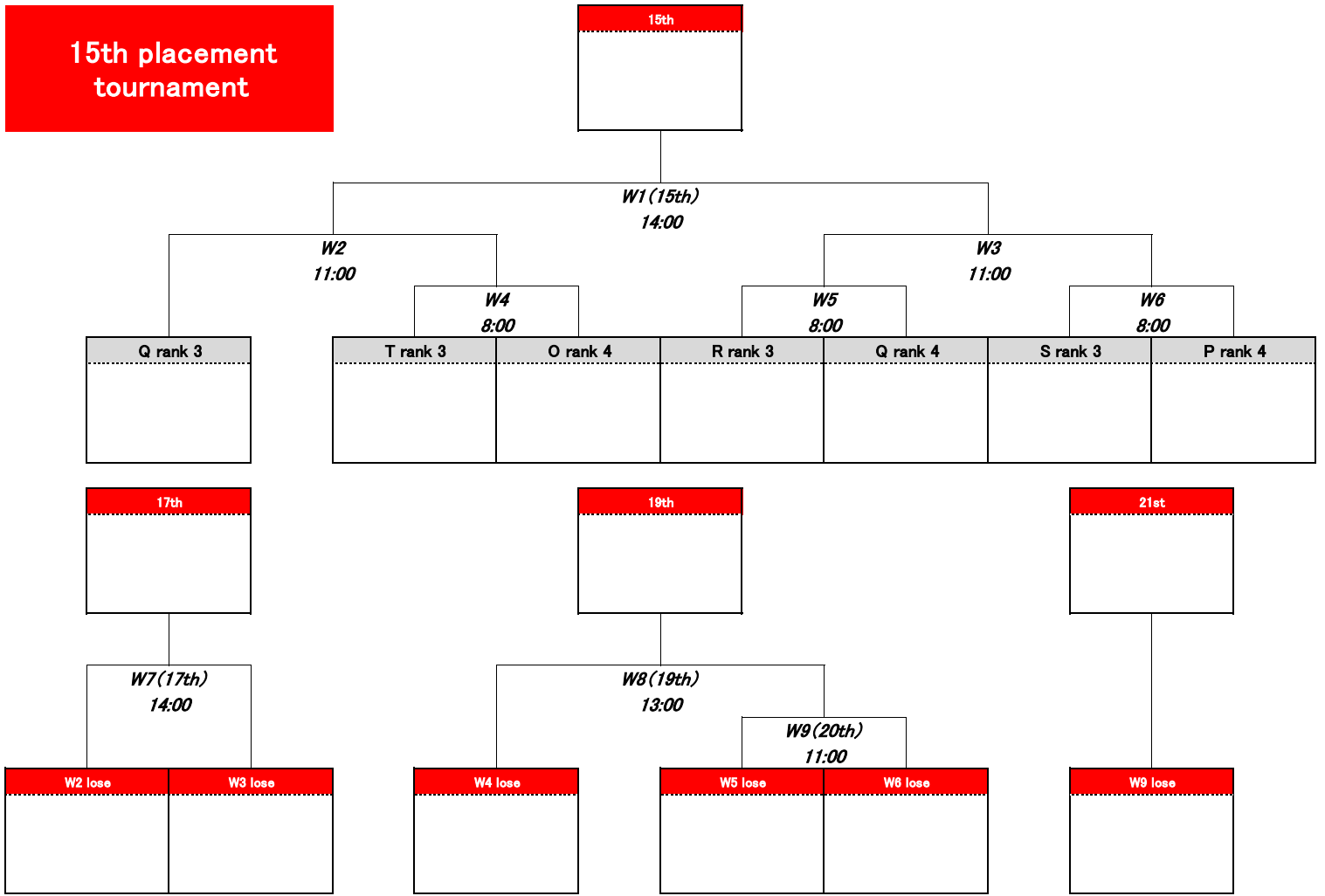

22nd placement tournament

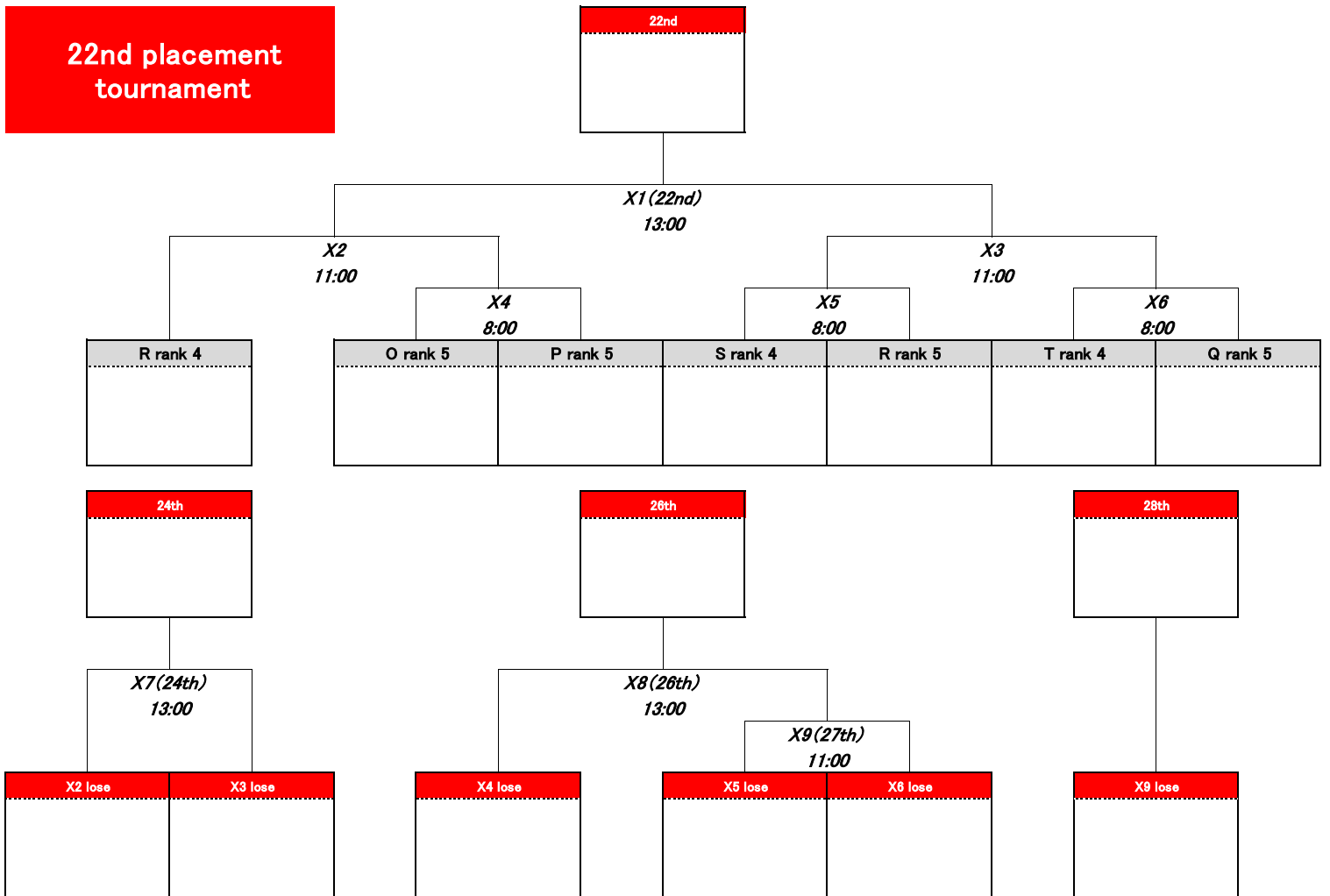

29th placement  
tournament

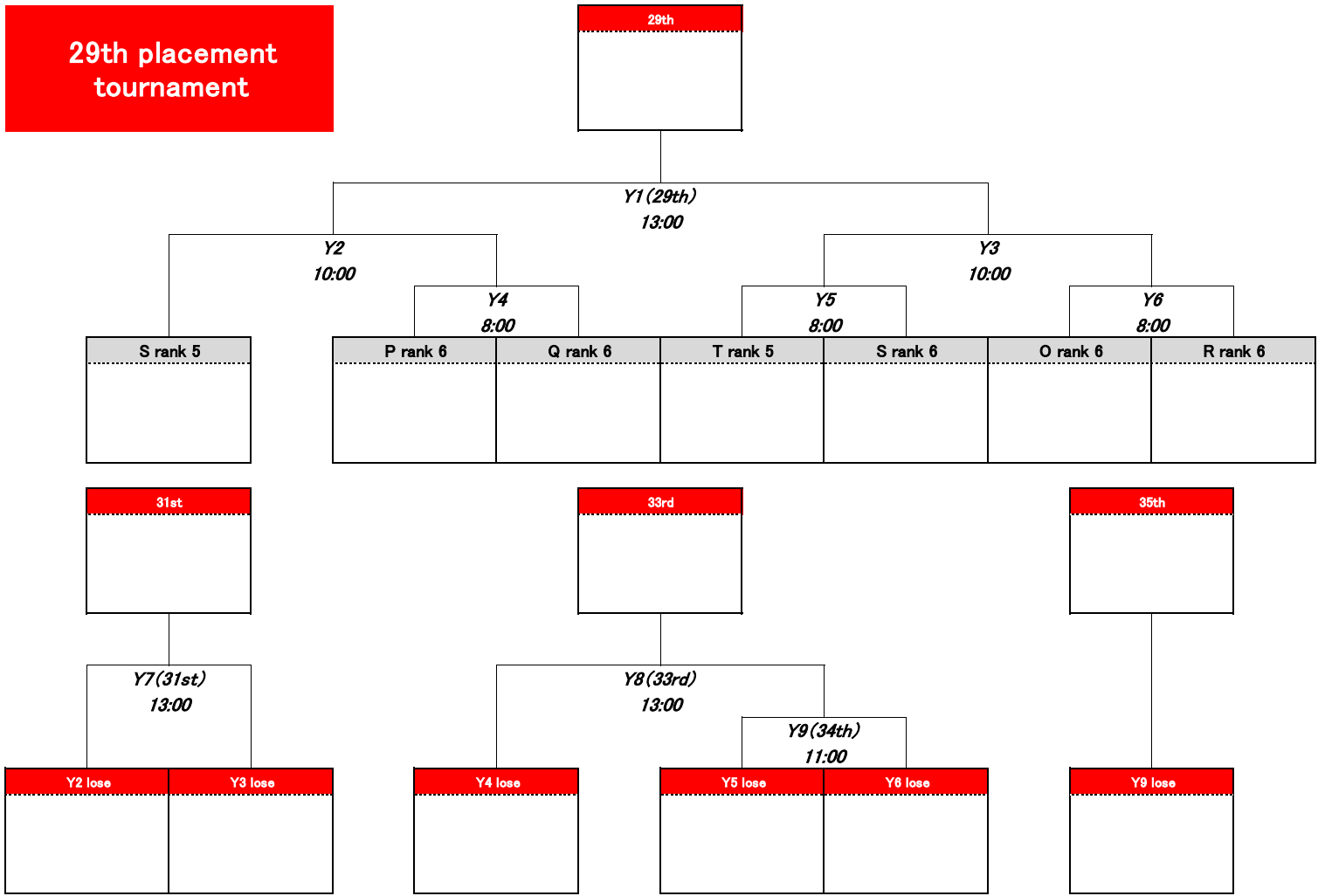

36th placement  
tournament

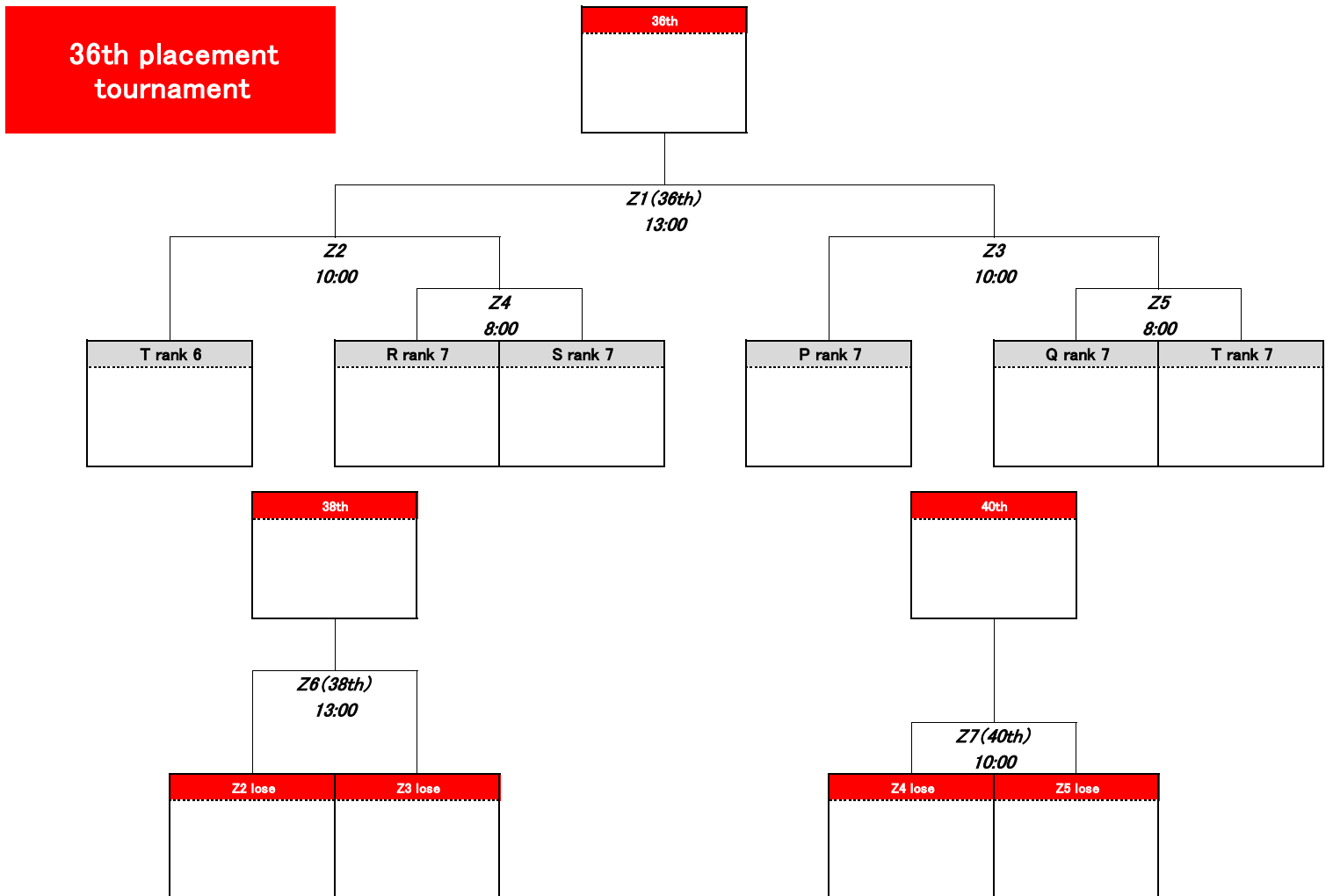

◇Schedule/Day1◇

		Field1	Field2	Field3	Field4	Field5	Field6	Field7	Field8	Field9	Field10	Field11	Field12	Field13	Field14	Field15	Field16
1	8:00	Tournament O	Tournament O	Tournament P	Tournament P	Tournament P	Tournament Q	Tournament Q	Tournament Q	Tournament R	Tournament R	Tournament R	Tournament S	Tournament S	Tournament S	Tournament T	Tournament T
		名古屋Blooms	東京外国語大学MAX	神戸大学BEEFREE	日本大学Hummingbirds	立命館大学Ludolph	東京都立大学BUTTERFLY	慶應義塾大学WHITEHORNS	大阪体育大学BOUHSSEARS	愛知産業大学GARNET'S	東京学芸大学BIGAPPLE	中京大学Naughty Kids	静岡大学GLANZ	学習院大学ER	宇都宮大学Chaoz*	順天堂大学Anemos	筑波大学INVERHOUSE
		<b>O4</b>	<b>O5</b>	<b>P4</b>	<b>P5</b>	<b>P6</b>	<b>Q4</b>	<b>Q5</b>	<b>Q6</b>	<b>R4</b>	<b>R5</b>	<b>R6</b>	<b>S4</b>	<b>S5</b>	<b>S6</b>	<b>T4</b>	<b>T5</b>
		Tournament O	Tournament O	Tournament P	Tournament P	Tournament P	Tournament Q	Tournament Q	Tournament Q	Tournament R	Tournament R	Tournament R	Tournament S	Tournament S	Tournament S	Tournament T	Tournament T
		國學院大学TRUMP	静岡県立大学Arcobaleno	文政大学AIRS	中央大学CLAN	信州大学LOOSE	北海道大学PADDY	びわこ成蹊スポーツ大学Lakers	静岡大学うわの空	上智大学FREAKS	大阪狭義校ALBA	上海山陽青少年女子LLGirls	慶應義塾大学HUSKIES	関西学院大学ARROWS	京都大学BREEZE	国際基督教大学WINDS	東北大学ALBATROSS
2	9:00	Tournament A	Tournament A	Tournament A	Tournament B	Tournament B	Tournament B	Tournament C	Tournament C	Tournament C	Tournament C	Tournament D	Tournament D	Tournament D	Tournament D	Tournament E	Tournament T
		近畿大学	東洋大学JAVELINAUTS	学習院大学ER	日本大学Hummingbirds	名古屋大学Blooms	東北大学ALBATROSS	同志社大学Magic	大阪大学ENN	東京大学ShWalkers	駒澤大学Mizuro	東京都立大学BUTTERFLY	静岡大学うわの空	関西学院大学ARROWS	神戸大学BEE FREE	立命館大学Ludolph	大阪大学cerohio
		<b>A4</b>	<b>A5</b>	<b>A6</b>	<b>B4</b>	<b>B5</b>	<b>B6</b>	<b>C4</b>	<b>C5</b>	<b>C6</b>	<b>C7</b>	<b>D4</b>	<b>D5</b>	<b>D6</b>	<b>D7</b>	<b>E4</b>	<b>T6</b>
		Tournament A	Tournament A	Tournament A	Tournament B	Tournament B	Tournament B	Tournament C	Tournament C	Tournament C	Tournament C	Tournament D	Tournament D	Tournament D	Tournament D	Tournament E	Tournament T
		横浜国立大学Cougars	上海山陽青少年飛鳥隊	京都大学BREEZE	東京学芸大学BIGAPPLE	大阪狭義校PLUM BONDS	慶應義塾大学HUSKIES	法政大学ASA-MAC'S	明星大学SPARKS	山梨大学Cyclone	宇都宮大学HOTSOREAM	龍谷大学ROC-A-AIR Jr	中京大学FLIPPERS	愛知大学NEXUS	中央大学CLAN	日本体育大学BARBARIANS	日本体育大学BARBARIANS
3	10:00	Tournament O	Tournament O	Tournament P	P5 win	Tournament Q	Tournament E	Tournament E	Tournament E	Tournament F	Tournament F	Tournament F	Tournament F	Tournament G	Tournament G	Tournament G	Tournament G
		龍谷大学ROC-A-AIR	常葉大学INDIES	東洋大学JAVELINAUTS		法政大学ASA-MAC'S	早稲田大学SONICS B	慶應義塾大学Whitehorns	順天堂大学Anemos	國學院大学TRUMP	静岡県立大学Arcobaleno	筑波大学INVERHOUSE	千葉大学MISTRAL	龍谷大学ROC-A-AIR	九州大学NICK	明治大学FreeFliers	信州大学LOOSE
		<b>O2</b>	<b>O3</b>	<b>P2</b>	<b>P3</b>	<b>Q2</b>	<b>E5</b>	<b>E6</b>	<b>E7</b>	<b>F4</b>	<b>F5</b>	<b>F6</b>	<b>F7</b>	<b>G4</b>	<b>G5</b>	<b>G6</b>	<b>G7</b>
		O4 win	O5 win	P4 win	P6 win	Q4 win		Tournament E	Tournament E	Tournament E	Tournament F	Tournament F	Tournament F	Tournament G	Tournament G	Tournament G	Tournament G
							中部大学BLAVES	大阪狭義校ALBA	北海道大学PADDY	法政大学FOXYSI!	東京外国語大学MAX	文政大学AIRS	獨仙大学WAFT	愛知産業大学GARNETS	上智大学FREAKS	静岡大学GLANZ	国際基督教大学WINDS
4	11:00	Tournament A	A5 win	A5 lose	O4 lose	P5 lose	Q5 win	Q5 lose	Tournament R	R5 win	R5 lose	Tournament S	S5 win	S5 lose	Tournament T	T5 win	T5 lose
		大阪体育大学BOUHSSEARS								早稲田大学SONICS							
		<b>A2</b>	<b>A3</b>	<b>A9</b>	<b>O7</b>	<b>P9</b>	<b>Q9</b>	<b>Q9</b>	<b>R2</b>	<b>R9</b>	<b>R9</b>	<b>S2</b>	<b>S9</b>	<b>S9</b>	<b>T2</b>	<b>T9</b>	<b>T9</b>
		A4 win	A6 win	A8 lose	O5 lose	P6 lose	Q6 win	Q6 lose	D4 win	D6 win	D6 lose	S4 win	S6 win	S6 lose	T4 win	T6 win	T6 lose
5	12:00	Tournament B	B5 win	B5 lose	O4 win	O5 win	O4 lose	O6 lose	D4 win	D6 win	D4 lose	D6 lose	E4 win	E6 win	E4 lose	E6 lose	F4 win
		早稲田大学SONICS															
		<b>B2</b>	<b>B3</b>	<b>B9</b>	<b>O2</b>	<b>O3</b>	<b>O10</b>	<b>O11</b>	<b>D2</b>	<b>D3</b>	<b>D10</b>	<b>D11</b>	<b>E2</b>	<b>E3</b>	<b>E10</b>	<b>E11</b>	<b>F2</b>
		B4 win	B6 win	B8 lose	O5 win	O7 win	O5 lose	O7 lose	D5 win	D7 win	D5 lose	D7 lose	E5 win	E7 win	E5 lose	E7 lose	F5 win
6	13:00	O2 win	O2 lose	P2 win	P2 lose	P4 lose	Q2 win	Q2 lose	Q4 lose	R2 win	F6 win	F4 lose	F6 lose	G4 win	G6 win	G4 lose	G6 lose
		<b>O1</b>	<b>O6</b>	<b>P1</b>	<b>P7</b>	<b>P8</b>	<b>Q1</b>	<b>Q7</b>	<b>Q8</b>	<b>R1</b>	<b>F3</b>	<b>F10</b>	<b>F11</b>	<b>G2</b>	<b>G3</b>	<b>G10</b>	<b>G11</b>
		O3 win	O3 lose	P3 win	P3 lose	P6 win	Q3 win	Q3 lose	Q6 win	R3 win	F7 win	F5 lose	F7 lose	G5 win	G7 win	G5 lose	G7 lose
7	14:00	A2 win	A2 lose	A4 lose	B2 win	B2 lose	B4 lose	O2 win	O2 lose	R2 lose	R4 lose	S2 win	S2 lose	S4 lose	T2 win	T2 lose	T4 lose
		<b>A1</b>	<b>A7</b>	<b>A8</b>	<b>B1</b>	<b>B7</b>	<b>B8</b>	<b>O1</b>	<b>O3</b>	<b>R7</b>	<b>R8</b>	<b>S1</b>	<b>S7</b>	<b>S8</b>	<b>T1</b>	<b>T7</b>	<b>T8</b>
		A3 win	A3 lose	A6 win	B3 win	B3 lose	B6 win	O3 win	O3 lose	R3 lose	R6 win	S3 win	S3 lose	S6 win	T3 win	T3 lose	T6 win
8	15:00	G10 win	G10 lose	D2 win	D2 lose	D10 win	D10 lose	E2 win	E2 lose	E10 win	E10 lose	F2 win	F2 lose				
		<b>G9</b>	<b>G12</b>	<b>D1</b>	<b>D6</b>	<b>D9</b>	<b>D12</b>	<b>E1</b>	<b>E6</b>	<b>E9</b>	<b>E12</b>	<b>F1</b>	<b>F6</b>				
		G11 win	G11 lose	D3 win	D3 lose	D11 win	D11 lose	E3 win	E3 lose	E11 win	E11 lose	F3 win	F3 lose				
9	16:00	G2 win	G2 lose	G10 win	G10 lose							F10 win	F10 lose				
		<b>G1</b>	<b>G6</b>	<b>G9</b>	<b>G12</b>							<b>F9</b>	<b>F12</b>				
		G3 win	G3 lose	G11 win	G11 lose							F11 win	F11 lose				

◇Schedule/Day2◇

		Field1	Field2	Field3	Field4	Field5	Field6	Field7	Field8	Field9	Field10	Field11	Field12	Field13	Field14	Field15	Field16
1	8:00	R rank 1	P rank 1	S rank 2	Q rank 2	R rank 2	T rank 3	R rank 3	S rank 3	O rank 5	S rank 4	T rank 4	P rank 6	T rank 5	O rank 6	R rank 7	Q rank 7
		<b>U4</b>	<b>U5</b>	<b>V4</b>	<b>V5</b>	<b>V6</b>	<b>W4</b>	<b>W5</b>	<b>W6</b>	<b>X4</b>	<b>X5</b>	<b>X6</b>	<b>Y4</b>	<b>Y5</b>	<b>Y6</b>	<b>Z4</b>	<b>Z5</b>
		S rank 1	O rank 2	T rank 2	P rank 3	O rank 3	O rank 4	Q rank 4	P rank 4	P rank 5	R rank 5	Q rank 5	Q rank 6	S rank 6	R rank 6	S rank 7	T rank 7
2	9:00	Q rank 1	C rank 3	D rank 4	G rank 4	E rank 4	F rank 4	E rank 5	A rank 6	F rank 5	G rank 5	B rank 7	G rank 6	A rank 7	D rank 8	G rank 7	C rank 8
		<b>U6</b>	<b>J4</b>	<b>K4</b>	<b>K5</b>	<b>K6</b>	<b>K7</b>	<b>L4</b>	<b>L5</b>	<b>L6</b>	<b>L7</b>	<b>M4</b>	<b>M5</b>	<b>M6</b>	<b>N4</b>	<b>N5</b>	<b>N6</b>
		T rank 1	B rank 4	C rank 5	A rank 5	D rank 5	B rank 5	D rank 6	B rank 6	E rank 6	C rank 6	C rank 7	E rank 7	D rank 7	G rank 8	F rank 8	E rank 8
3	10:00	A rank 1	D rank 1	B rank 1	C rank 1	B rank 2	E rank 2	C rank 2	D rank 2	F rank 3	D rank 3	E rank 3	S rank 5	Y5 win	T rank 6	P rank 7	Z4 lose
		<b>H4</b>	<b>H5</b>	<b>H6</b>	<b>H7</b>	<b>I4</b>	<b>I5</b>	<b>I6</b>	<b>I7</b>	<b>J5</b>	<b>J6</b>	<b>J7</b>	<b>Y2</b>	<b>Y3</b>	<b>Z2</b>	<b>Z3</b>	<b>Z7 (40th)</b>
		G rank 1	E rank 1	A rank 2	F rank 1	A rank 3	F rank 2	B rank 3	G rank 2	G rank 3	C rank 4	A rank 4	Y4 win	Y6 win	Z4 win	Z5 win	Z6 lose
4	11:00	O rank 1	U5 win	U5 lose	P rank 2	V5 win	V5 lose	Q rank 3	W5 win	W5 lose	R rank 4	X5 win	X5 lose	Y5 lose	F rank 7	N5 win	N5 lose
		<b>U2</b>	<b>U3</b>	<b>U9 (8th)</b>	<b>V2</b>	<b>V3</b>	<b>V9 (13th)</b>	<b>W2</b>	<b>W3</b>	<b>W9 (20th)</b>	<b>X2</b>	<b>X3</b>	<b>X9 (27th)</b>	<b>Y9 (34th)</b>	<b>N2</b>	<b>N3</b>	<b>N9 (53rd)</b>
		U4 win	U6 win	U5 lose	V4 win	V6 win	V6 lose	W4 win	W6 win	W6 lose	X4 win	X6 win	X6 lose	Y6 lose	N4 win	N6 win	N6 lose
5	12:00	J4 win	J4 win	J6 win	J4 lose	J6 lose	K4 win	K6 win	K4 lose	K6 lose	L4 win	L6 win	L4 lose	L6 lose	F rank 6	M5 win	N5 lose
		<b>I2</b>	<b>J2</b>	<b>J3</b>	<b>J10</b>	<b>J11</b>	<b>K2</b>	<b>K3</b>	<b>K10</b>	<b>K11</b>	<b>L2</b>	<b>L3</b>	<b>L10</b>	<b>L11</b>	<b>M2</b>	<b>M3</b>	<b>M9 (40th)</b>
		I5 win	J5 win	J7 win	J5 lose	J7 lose	K5 win	K7 win	K5 lose	K7 lose	L5 win	L7 win	L5 lose	L7 lose	M4 win	M6 win	N6 lose
6	13:00	H4 win	H6 win	H4 lose	H6 lose	I6 win	I4 lose	I6 lose	W4 lose	X2 win	X2 lose	X4 lose	Y2 win	Y2 lose	Y4 lose	Z2 win	Z2 lose
		<b>H2</b>	<b>H3</b>	<b>H10</b>	<b>H11</b>	<b>I3</b>	<b>I10</b>	<b>I11</b>	<b>W9 (19th)</b>	<b>X1 (22nd)</b>	<b>X7 (24th)</b>	<b>X8 (28th)</b>	<b>Y1 (29th)</b>	<b>Y7 (31st)</b>	<b>Y8 (33rd)</b>	<b>Z1 (38th)</b>	<b>Z8 (58th)</b>
		H5 win	H7 win	H5 lose	H7 lose	I7 win	I5 lose	I7 lose	W6 win	X3 win	X3 lose	X6 win	Y3 win	Y3 lose	Y9 win	Z3 win	Z3 lose
7	14:00	U2 lose	U4 lose	V2 win	V2 lose	V4 lose	W2 win	W2 lose	L2 lose	L10 win	L10 lose	N2 win	N2 lose	N4 lose	M2 win	N2 lose	N4 lose
		<b>U7 (3rd)</b>	<b>U8 (5th)</b>	<b>V1 (8th)</b>	<b>V7 (10th)</b>	<b>V8 (12th)</b>	<b>W1 (15th)</b>	<b>W7 (17th)</b>	<b>L3 (35th)</b>	<b>L3 (37th)</b>	<b>L12 (39th)</b>	<b>N1 (40th)</b>	<b>N7 (50th)</b>	<b>N8 (52nd)</b>	<b>M1 (41st)</b>	<b>M7 (43rd)</b>	<b>M8 (45th)</b>
		U3 lose	U6 win	V5 win	V3 lose	V6 win	W5 win	W3 lose	L3 lose	L11 win	L11 lose	N3 win	N3 lose	N6 win	M3 win	N3 lose	N6 win
8	15:00	U2 win	I10 win	I10 lose	J2 win	J2 lose	J10 win	J10 lose	K2 win	K2 lose	K10 win	K10 lose	L2 win				
		<b>U1 (1st)</b>	<b>I8 (13th)</b>	<b>I12 (15th)</b>	<b>J1 (17th)</b>	<b>J8 (19th)</b>	<b>J8 (21st)</b>	<b>J12 (23rd)</b>	<b>K1 (25th)</b>	<b>K8 (27th)</b>	<b>K8 (29th)</b>	<b>K12 (31st)</b>	<b>L1 (33rd)</b>				
		U5 win	I1 win	I1 lose	J3 win	J3 lose	J11 win	J11 lose	K3 win	K3 lose	K11 win	K11 lose	L3 win				
9	16:00	H2 win	H2 lose	H10 win	H10 lose							I2 win	I2 lose				
		<b>H1 (1st)</b>	<b>H8 (3rd)</b>	<b>H9 (5th)</b>	<b>H12 (7th)</b>								<b>I1 (9th)</b>	<b>I8 (11th)</b>			
		H5 win	H3 lose	H11 win	H11 lose						I3 win	I3 lose	I3 win	I3 lose			