

2026 CLUB Jr ULTIMATE DREAM CUP~MIXED DIV.~
Qualifying tournament

A tournament

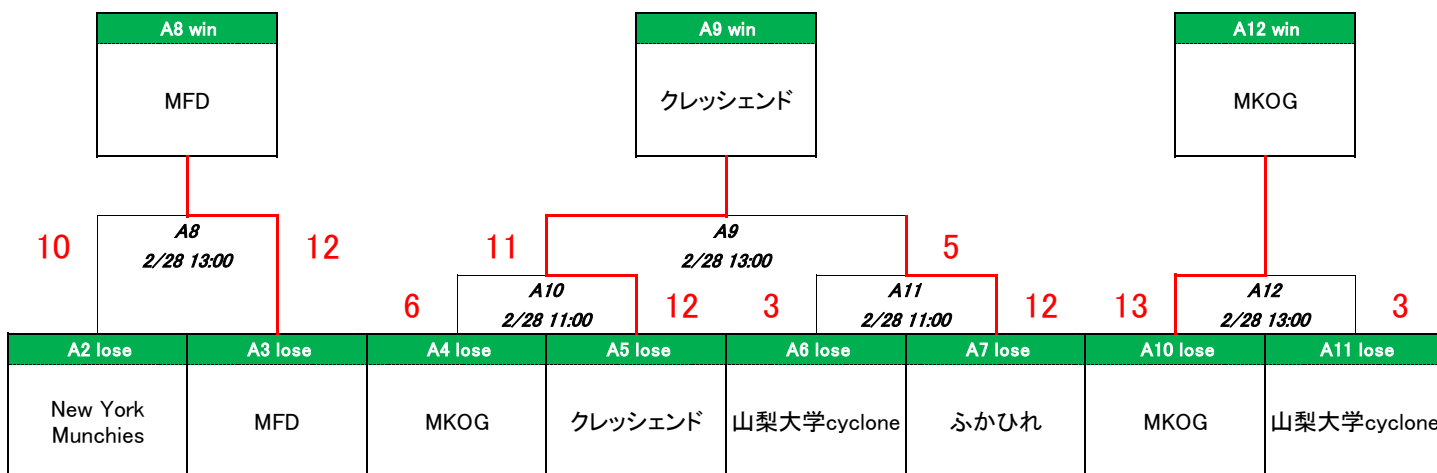

B tournament

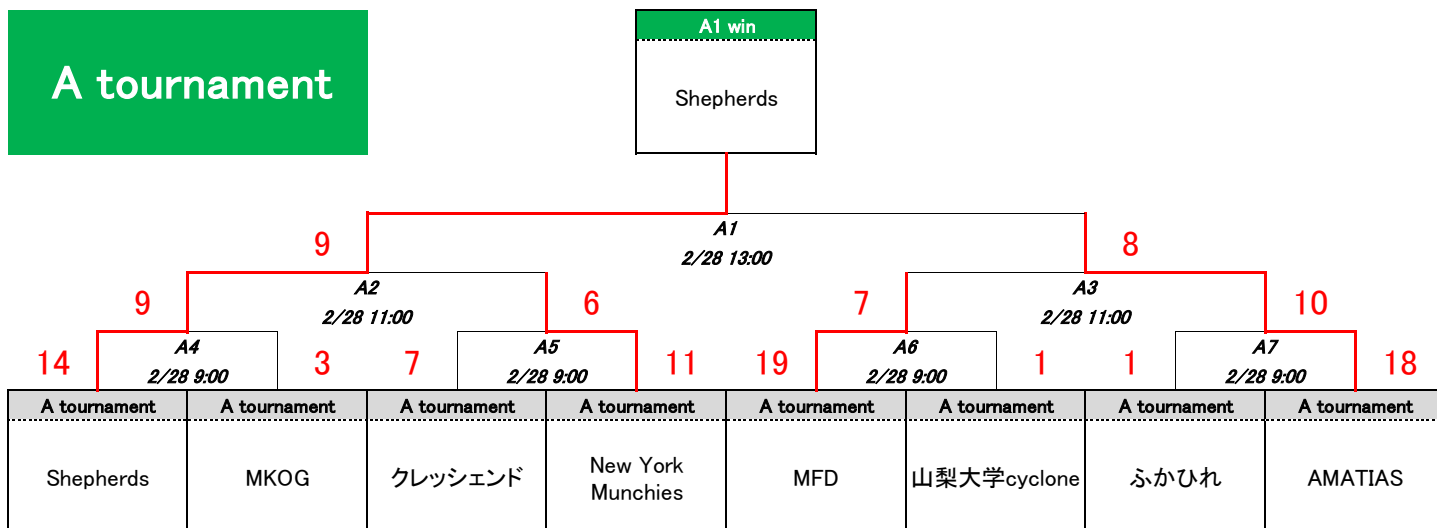
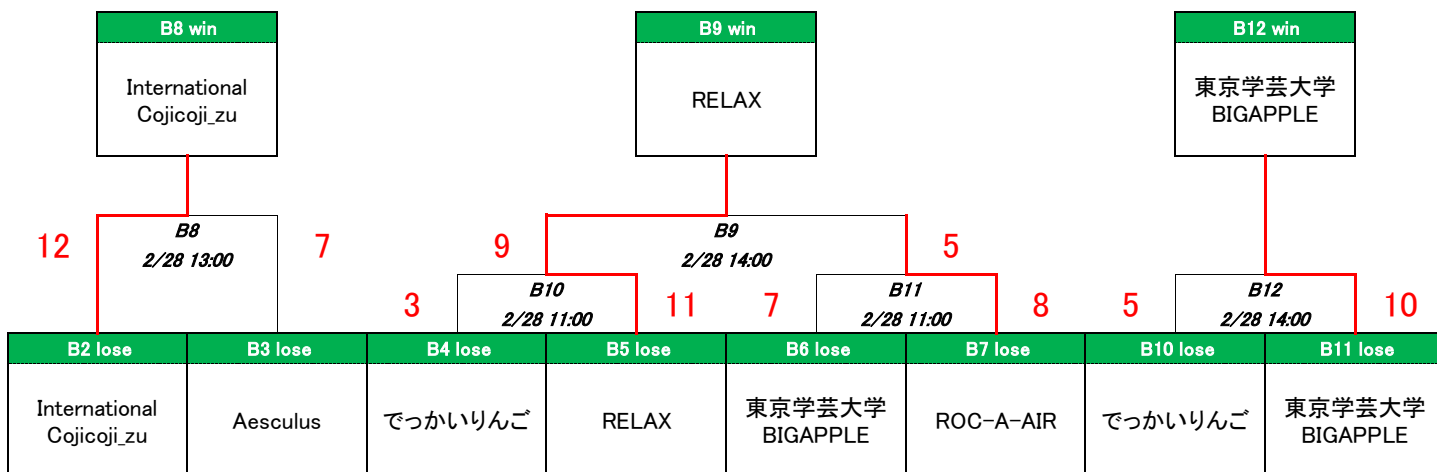
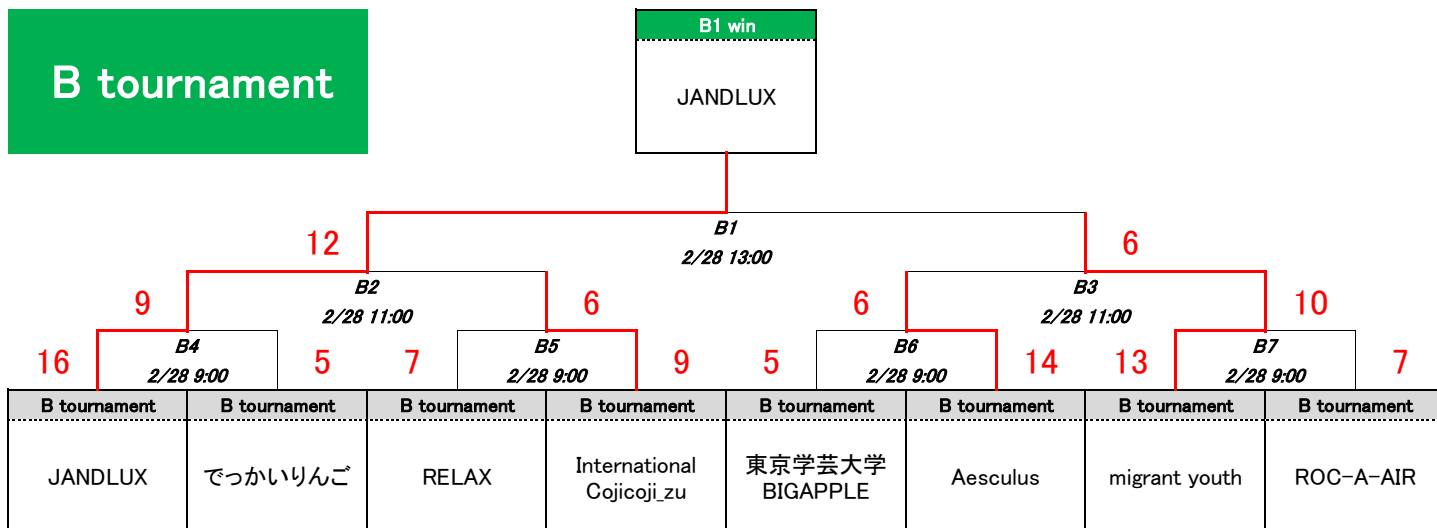

2026 CLUB Jr ULTIMATE DREAM CUP~MIXED DIV.~
Qualifying tournament

C tournament

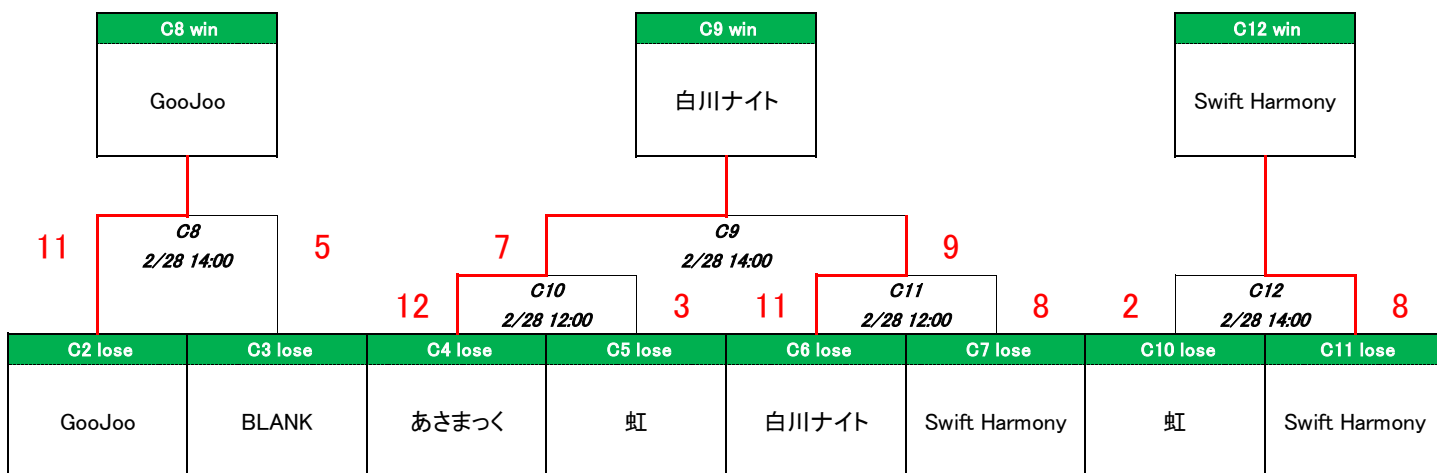
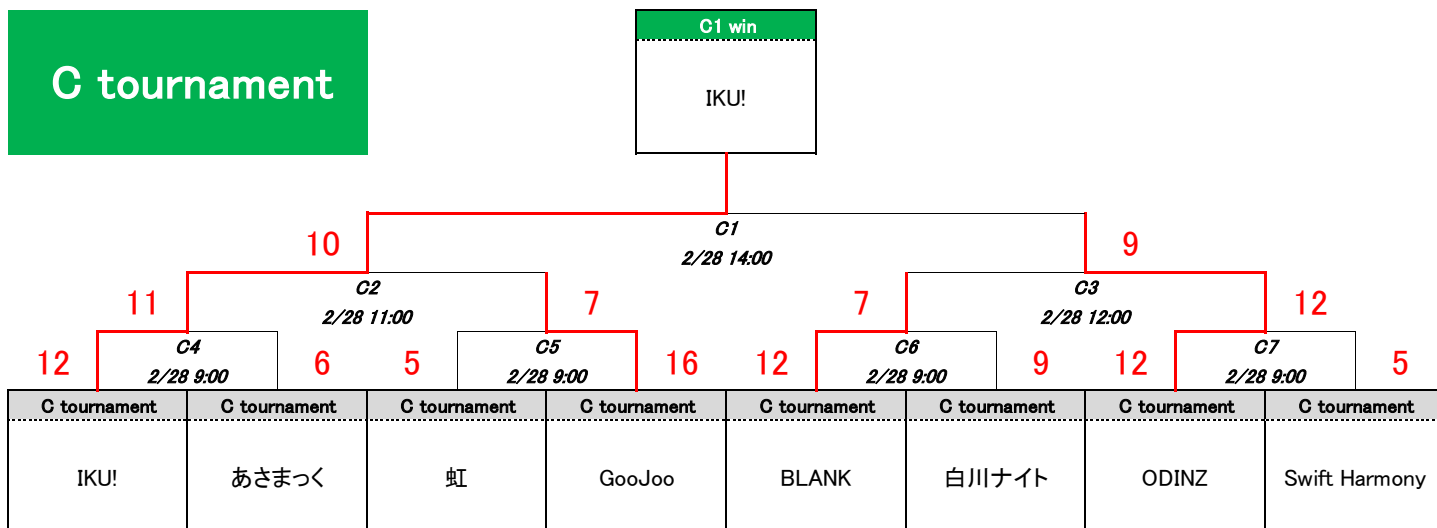

D tournament

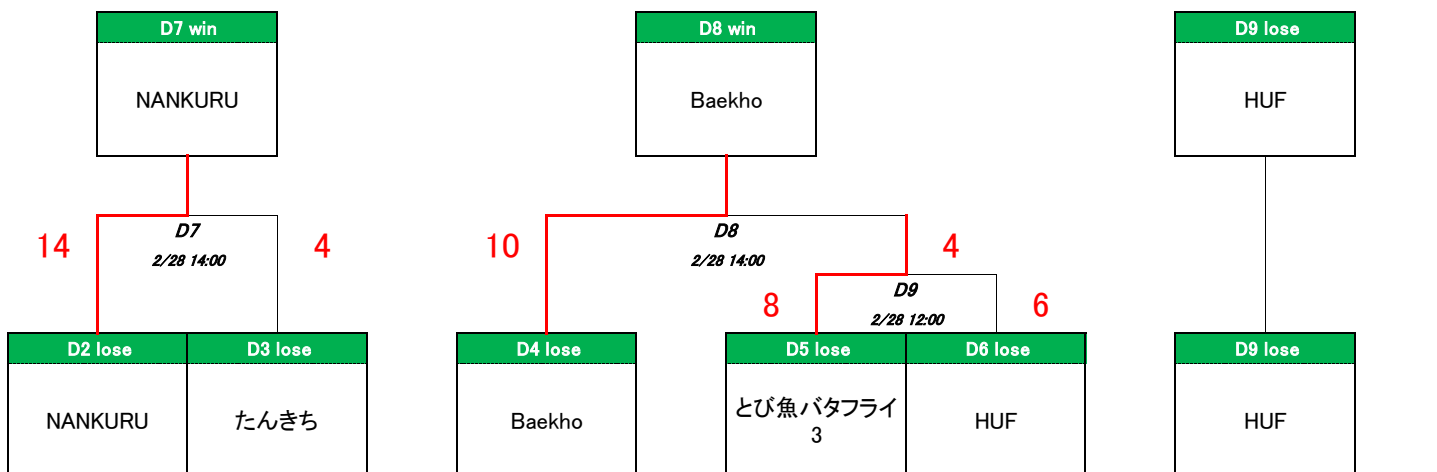
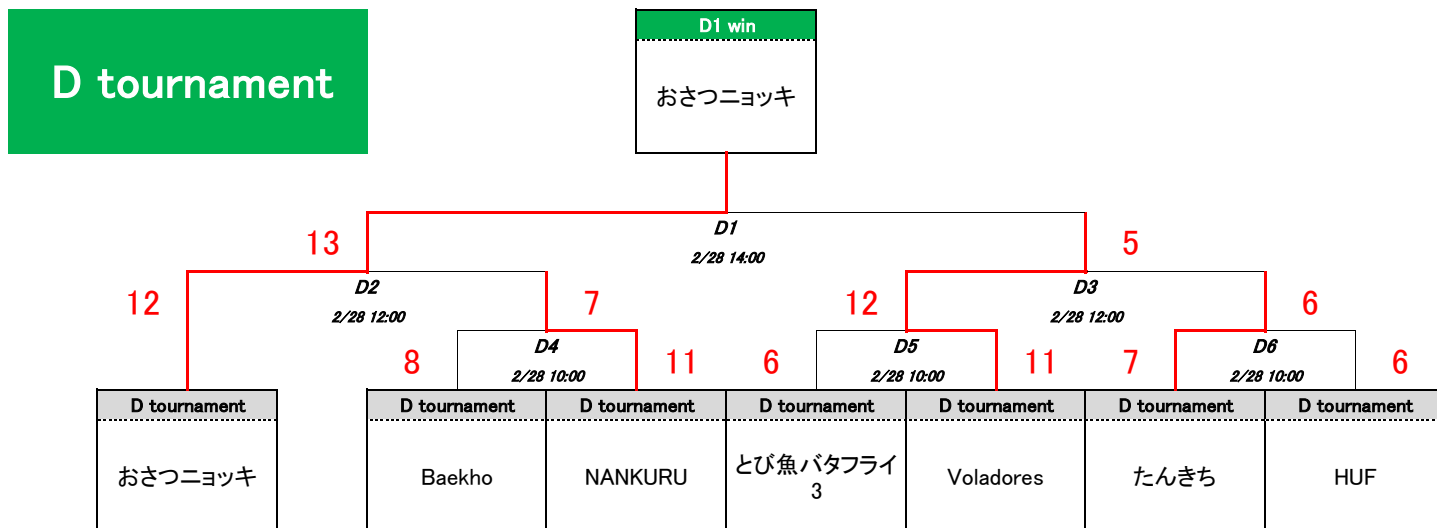

2026 CLUB Jr ULTIMATE DREAM CUP~MIXED DIV.~
Qualifying tournament

E tournament

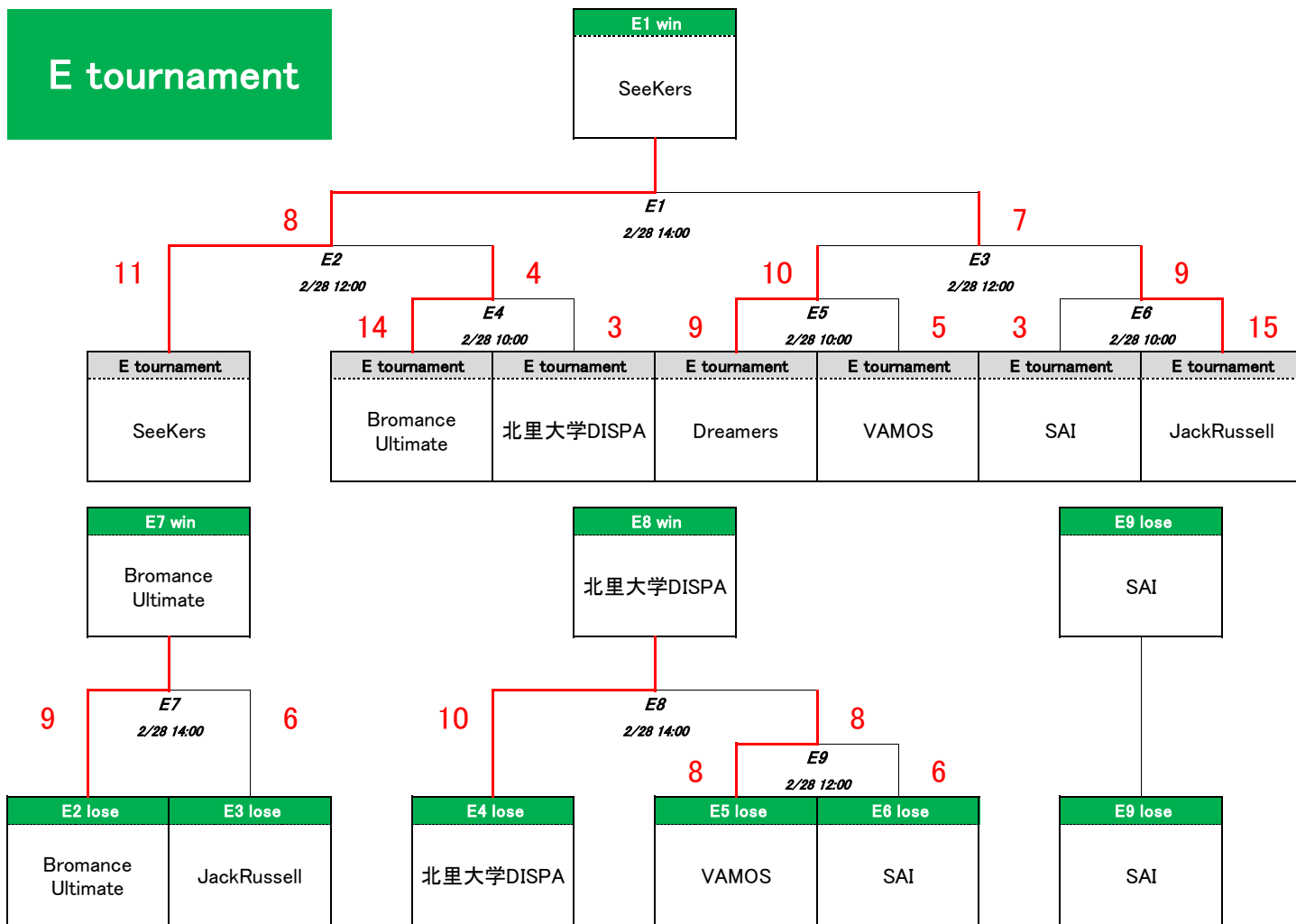

F tournament

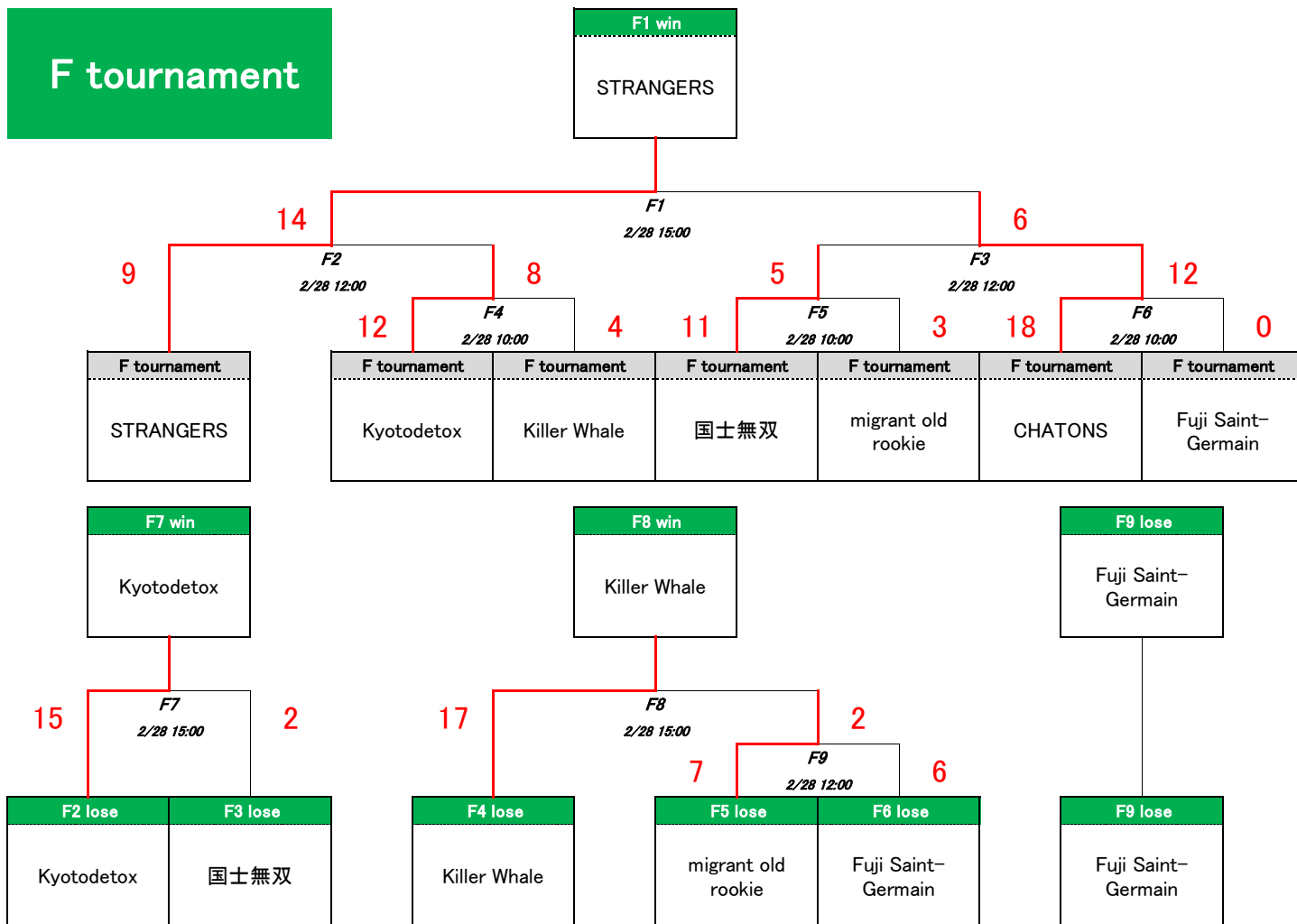

2026 CLUB Jr ULTIMATE DREAM CUP~MIXED DIV.~
Qualifying tournament

G tournament

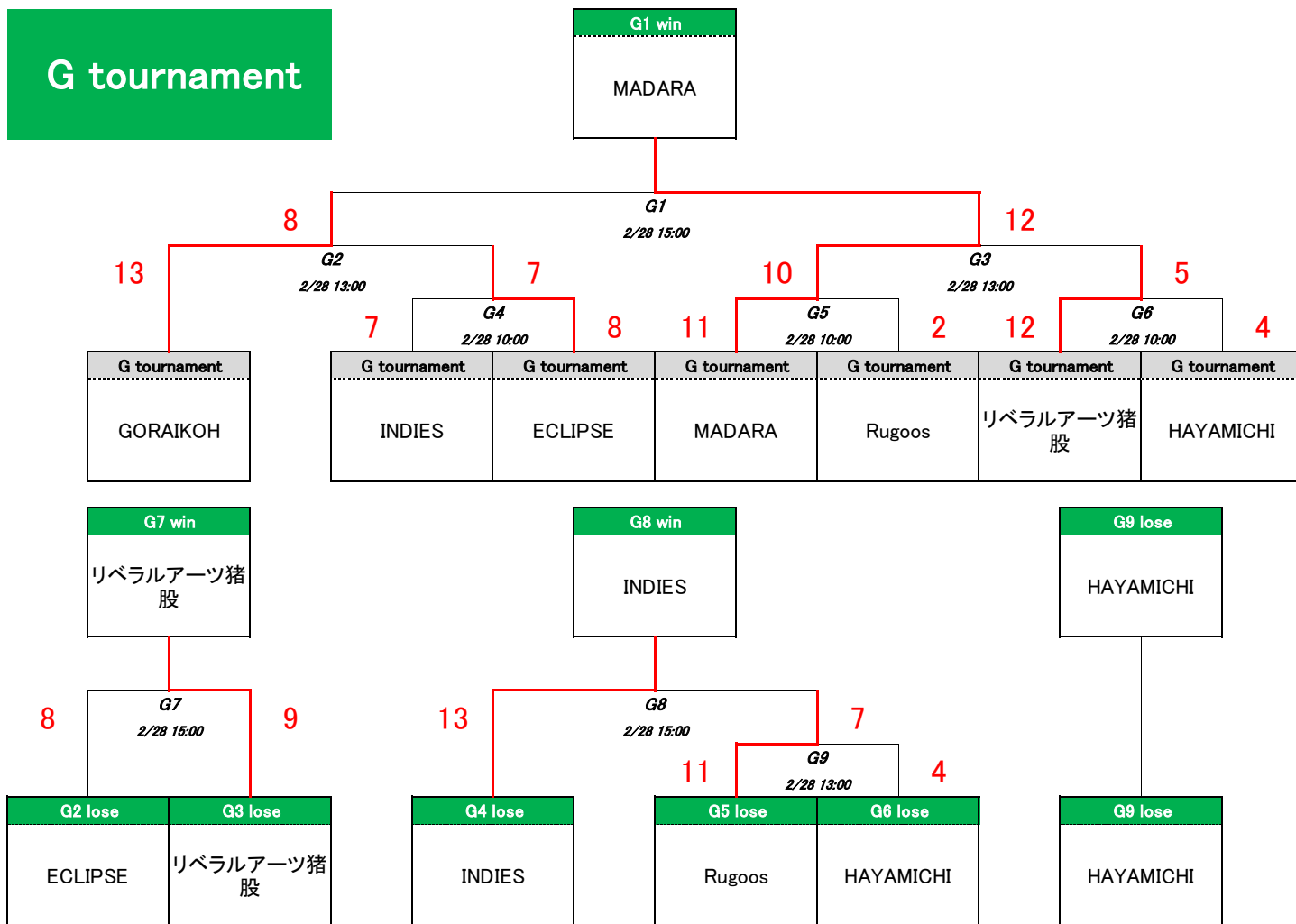

H tournament

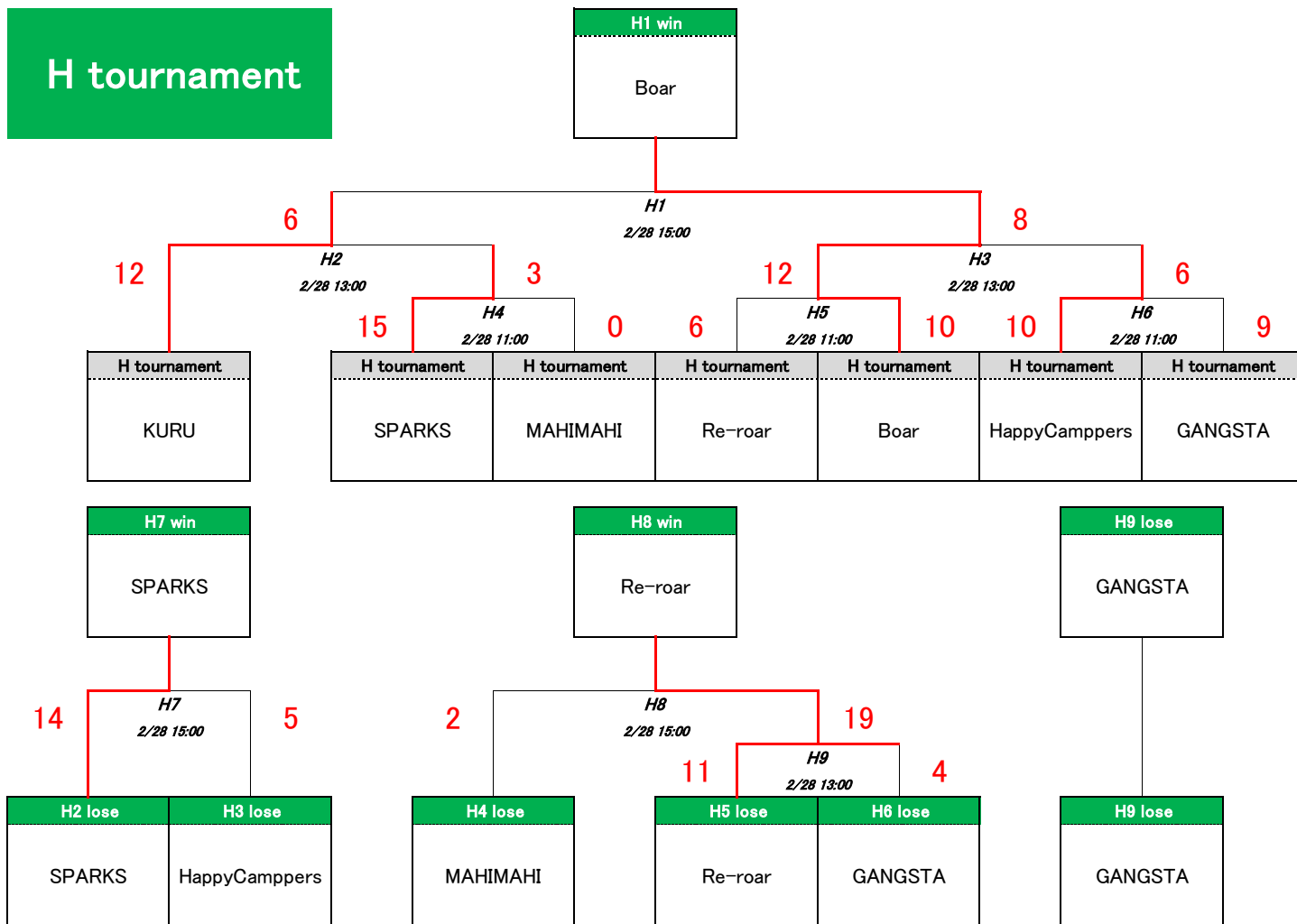

2026 CLUB Jr ULTIMATE DREAM CUP ~ MIXED DIV. ~

Qualifying tournament ranking

Tournament rank		TEAM NAME	NEXT
A tournament	1	Shepherds	1st placement tournament
B tournament		JANLUX	
C tournament		IKU!	
D tournament		おさつニヨッキ	
E tournament		SeeKers	
F tournament		STRANGERS	
G tournament		MADARA	
H tournament		Boar	
A tournament	2	AMATIAS	9th placement tournament
B tournament		migrant youth	
C tournament		ODINZ	
D tournament		Voladores	
E tournament		Dreamers	
F tournament		CHATONS	
G tournament		GORAIKOH	
H tournament		KURU	
A tournament	3	MFD	17th placement tournament
B tournament		International Cojicoji_zu	
C tournament		GooJoo	
D tournament		NANKURU	
E tournament		Bromance Ultimate	
F tournament		Kyotodetox	
G tournament		リベラルアーツ猪股	
H tournament		SPARKS	
A tournament	4	New York Munchies	25th placement tournament
B tournament		Aesculus	
C tournament		BLANK	
D tournament		たんきち	

E tournament		JackRussell	
F tournament		国士無双	
G tournament		ECLIPSE	
H tournament		HappyCampers	
A tournament	5	クレッシェンド	32nd placement tournament
B tournament		RELAX	
C tournament		白川ナイト	
D tournament		Baekho	
E tournament		北里大学DISPA	
F tournament		Killer Whale	
G tournament		INDIES	
H tournament		Re-roar	
A tournament	6	ふかひれ	39th placement tournament
B tournament		ROC-A-AIR	
C tournament		あさまっく	
D tournament		とび魚バタフライ3	
E tournament		VAMOS	
F tournament		migrant old rookie	
G tournament	Rugoos	46th placement tournament	
H tournament	MAHIMAHI		
A tournament	MKOG		
B tournament	東京学芸大学BIGAPPLE		
C tournament	Swift Harmony	53rd placement tournament	
D tournament	HUF		
E tournament	SAI		
F tournament	Fuji Saint-Germain		
G tournament	HAYAMICHI		
H tournament	GANGSTA		
A tournament	8		山梨大学cyclone
B tournament			でっかいりんご
C tournament		虹	

2026 CLUB Jr ULTIMATE DREAM CUP~MIXED DIV.~
Championship tournament

1st placement
tournament

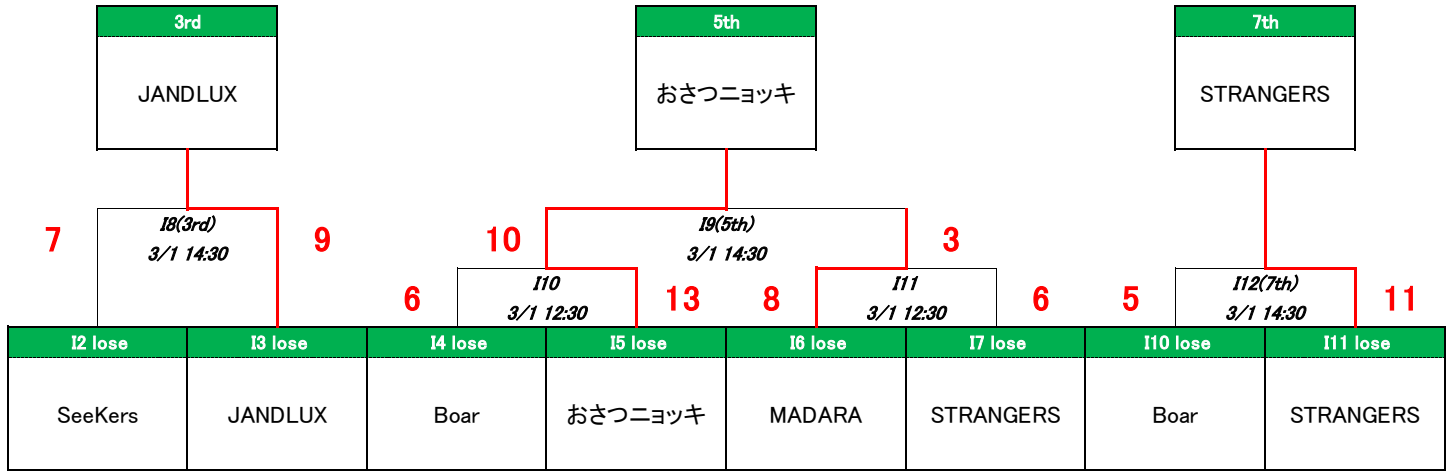
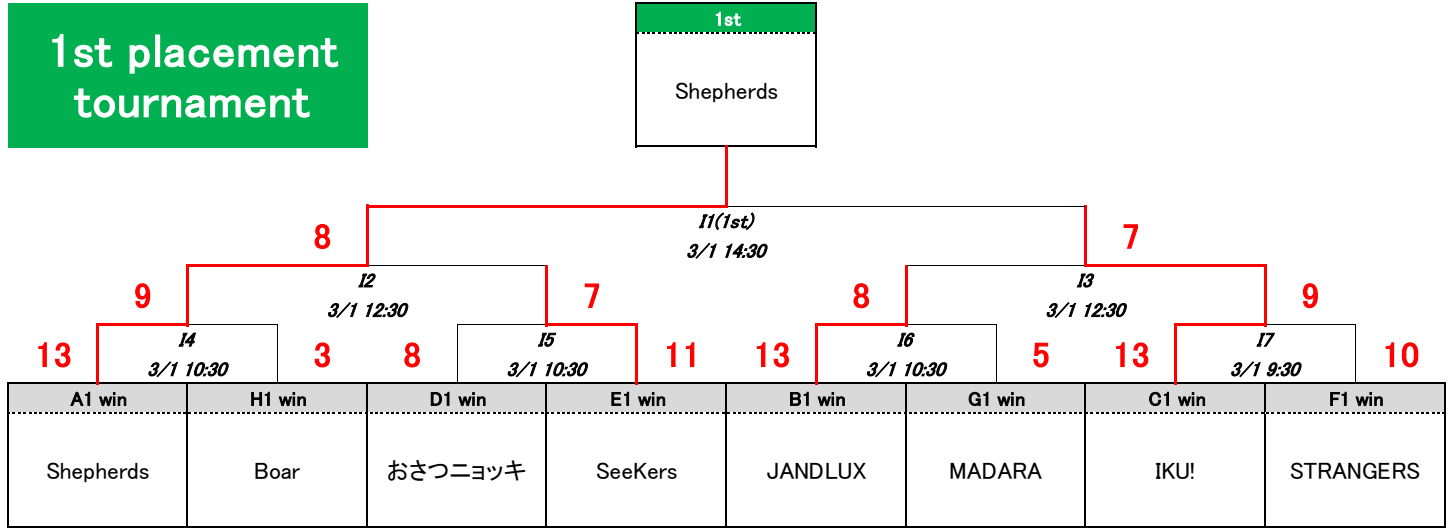

9th placement
tournament

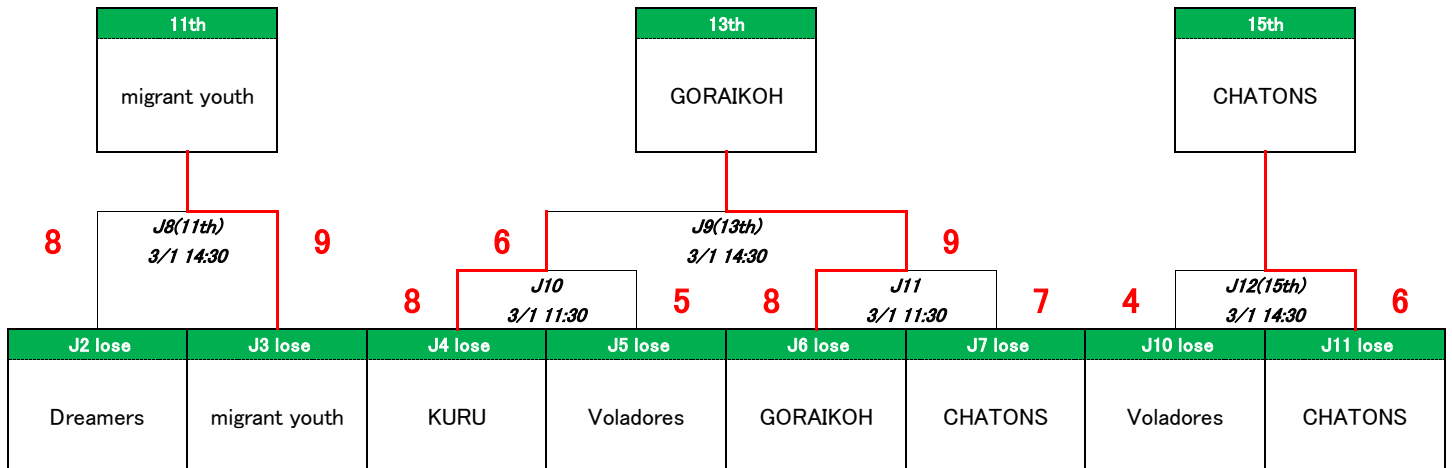
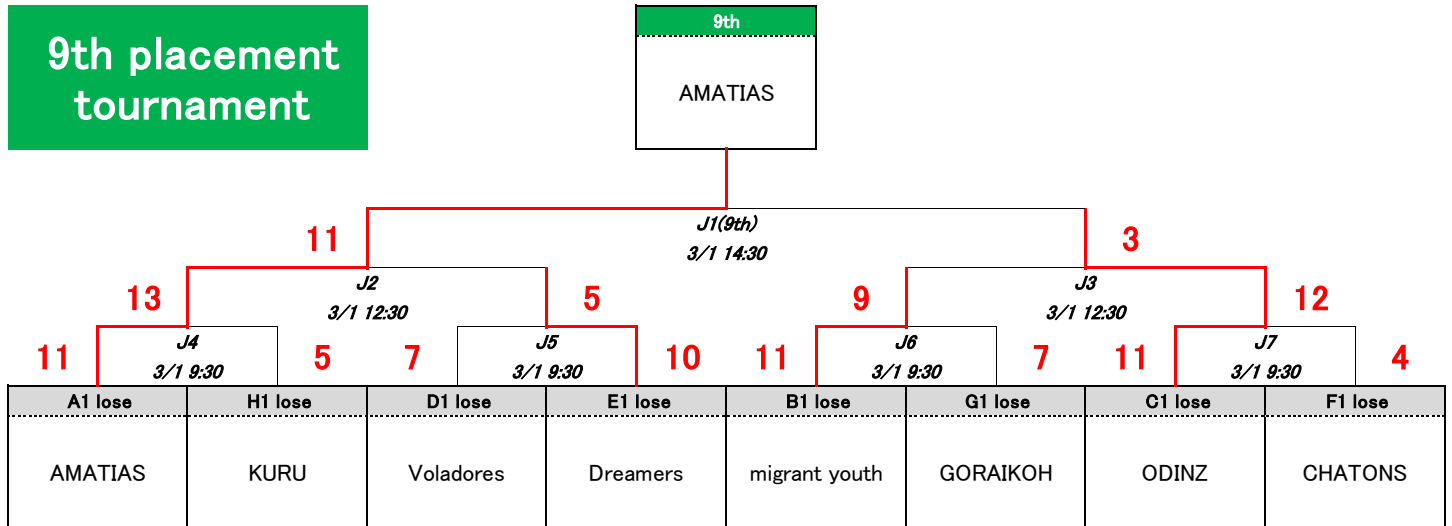

2026 CLUB Jr ULTIMATE DREAM CUP~MIXED DIV.~
Championship tournament

17th placement tournament

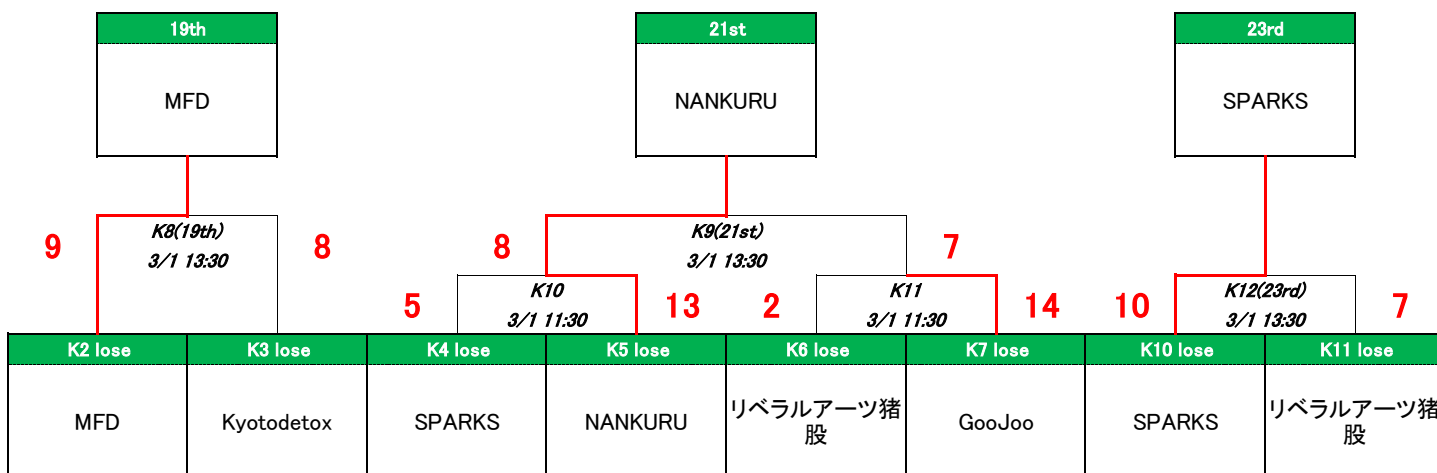
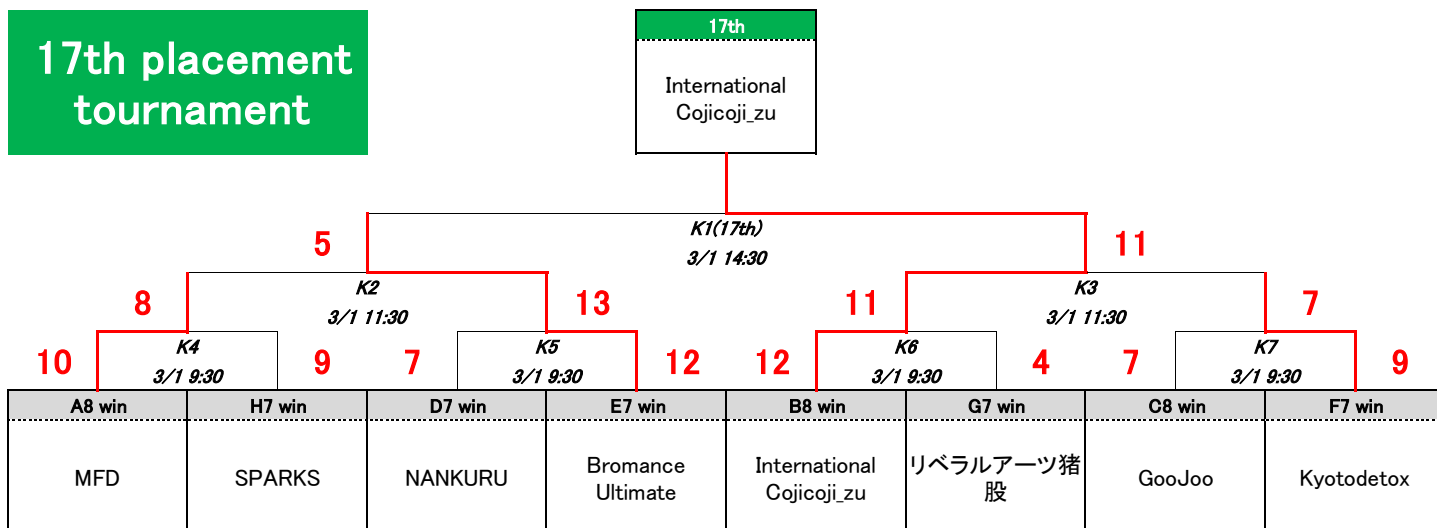

25th placement tournament

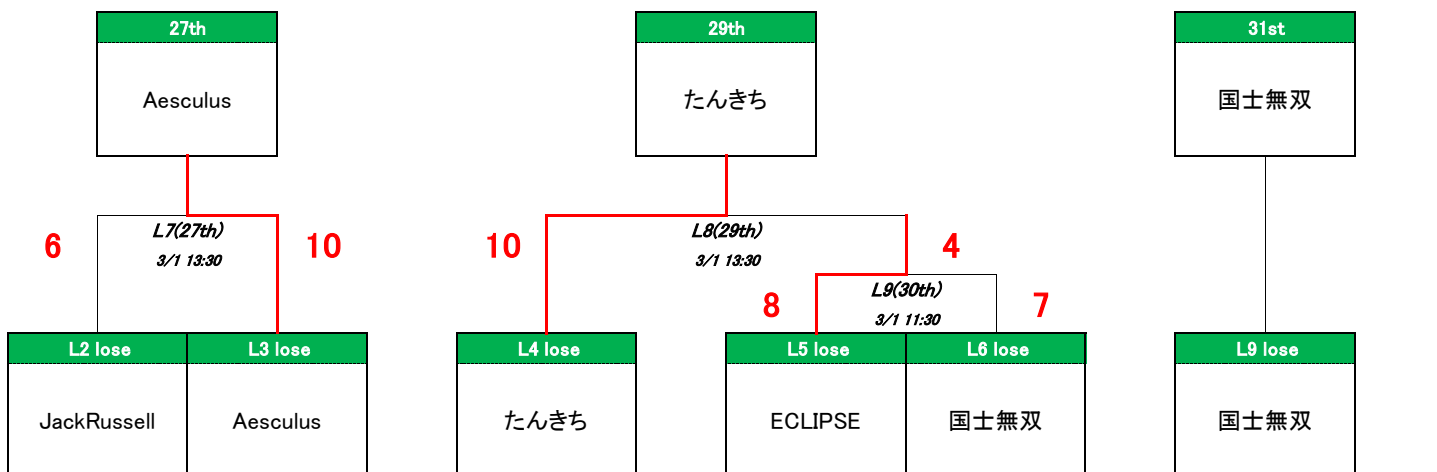
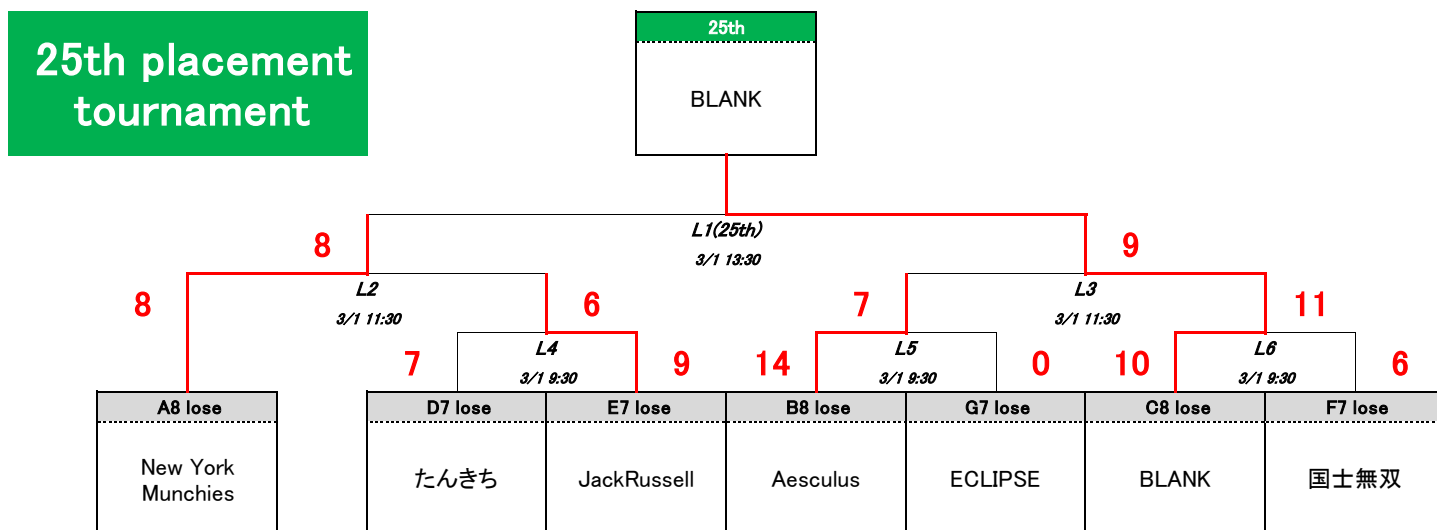

2026 CLUB Jr ULTIMATE DREAM CUP~MIXED DIV.~
Championship tournament

32nd placement tournament

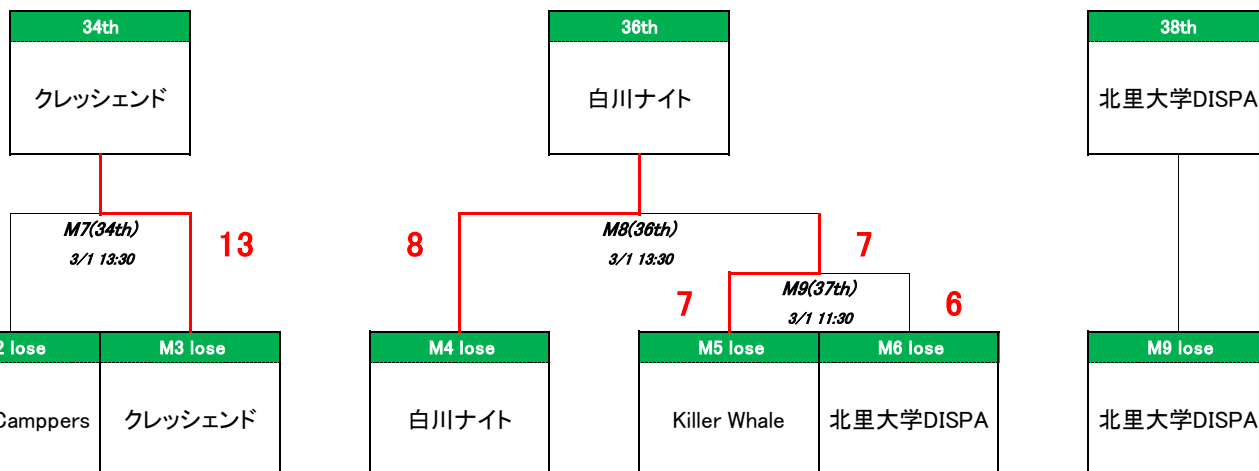
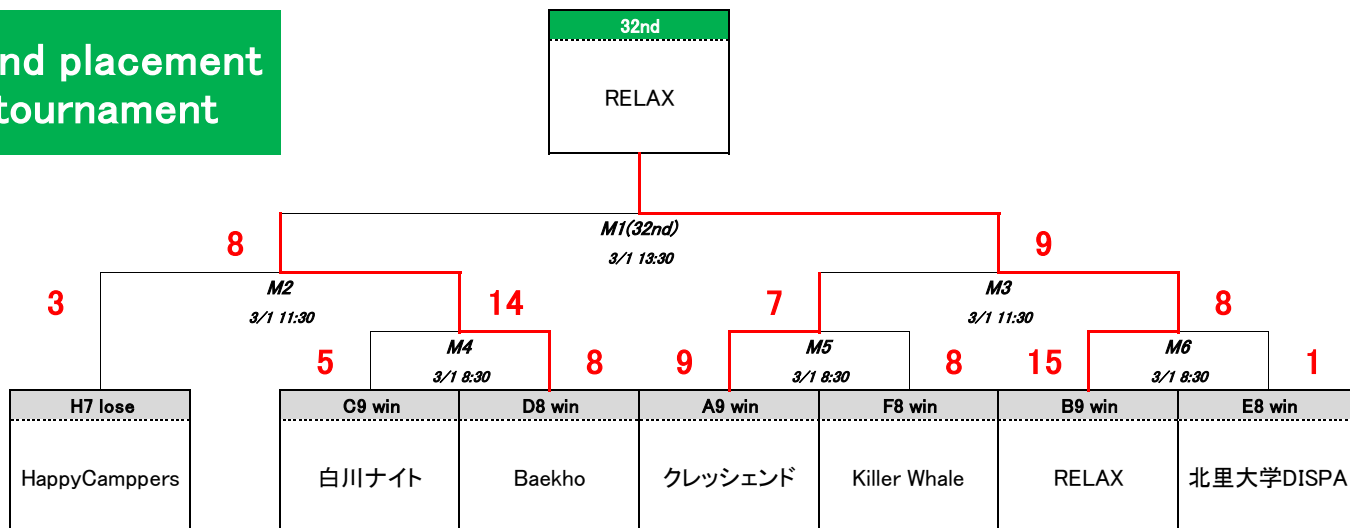

39th placement tournament

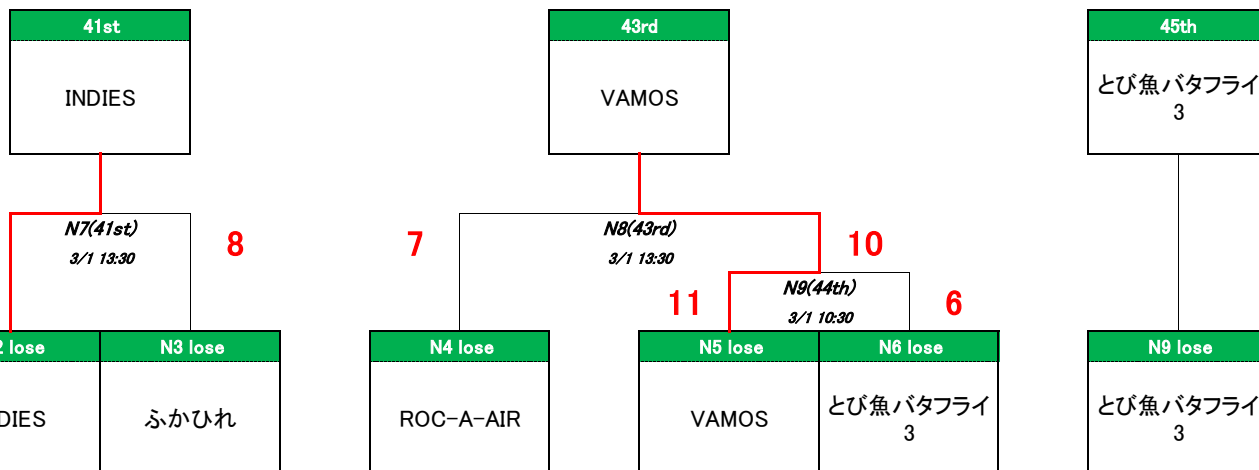
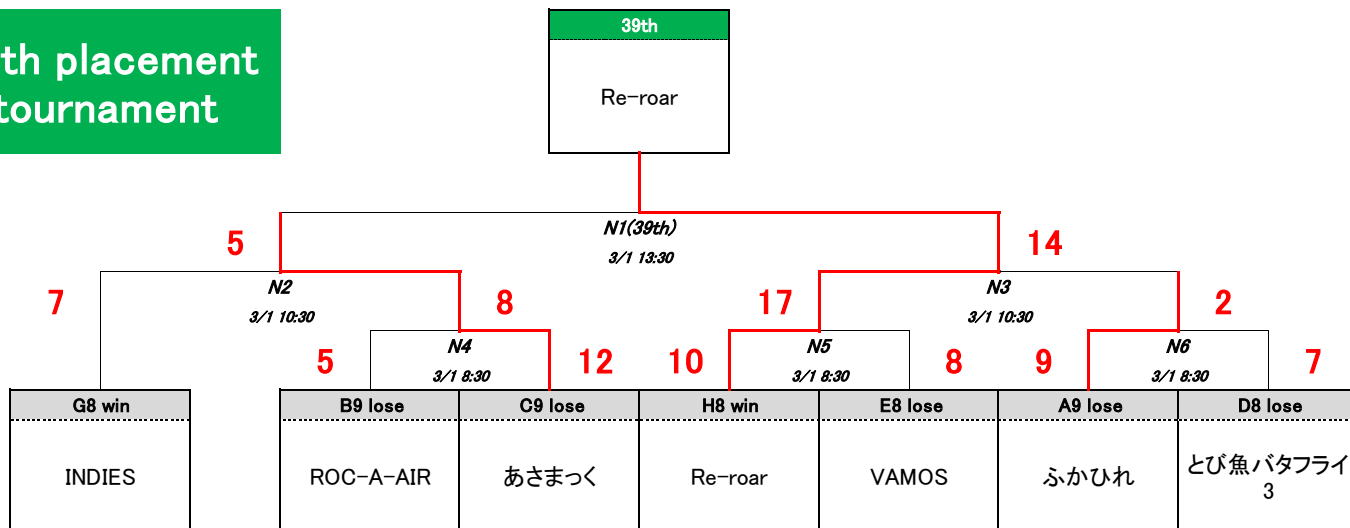

2026 CLUB Jr ULTIMATE DREAM CUP~MIXED DIV.~
Championship tournament

46th placement
tournament

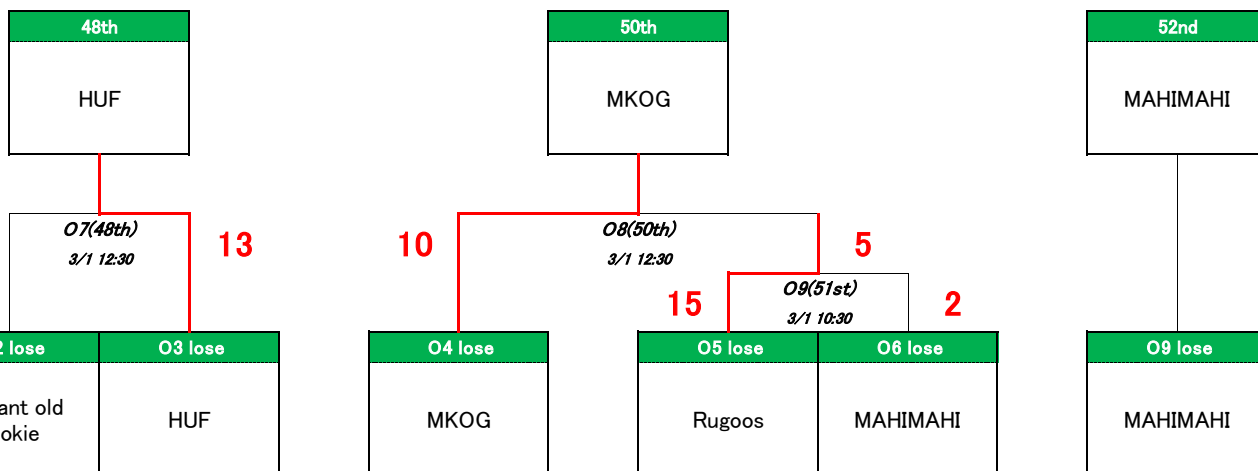
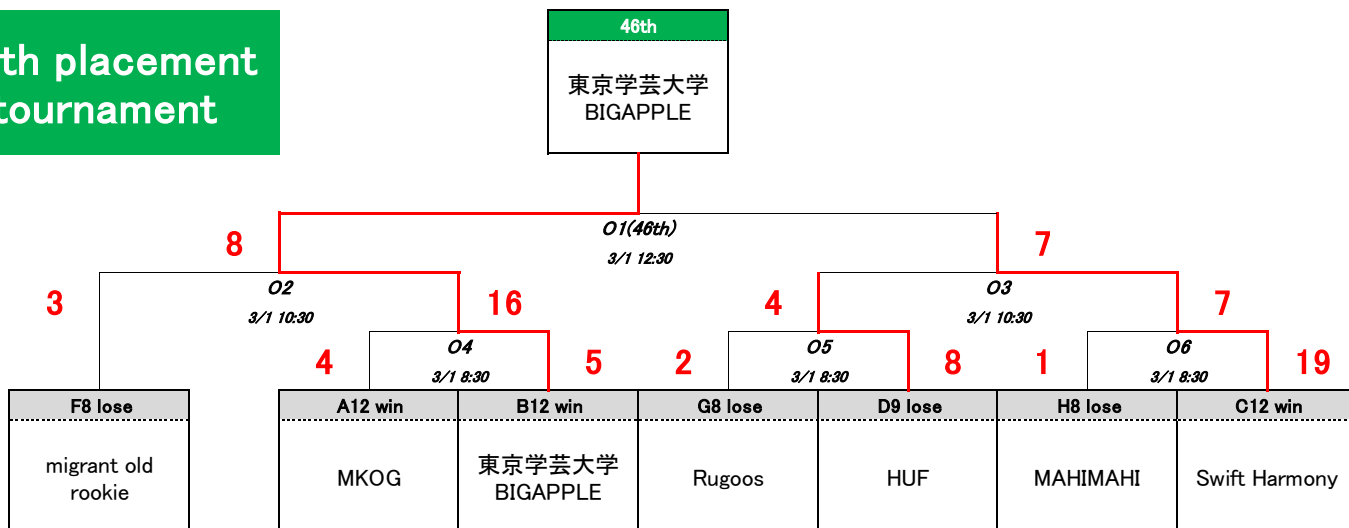

53rd placement
tournament

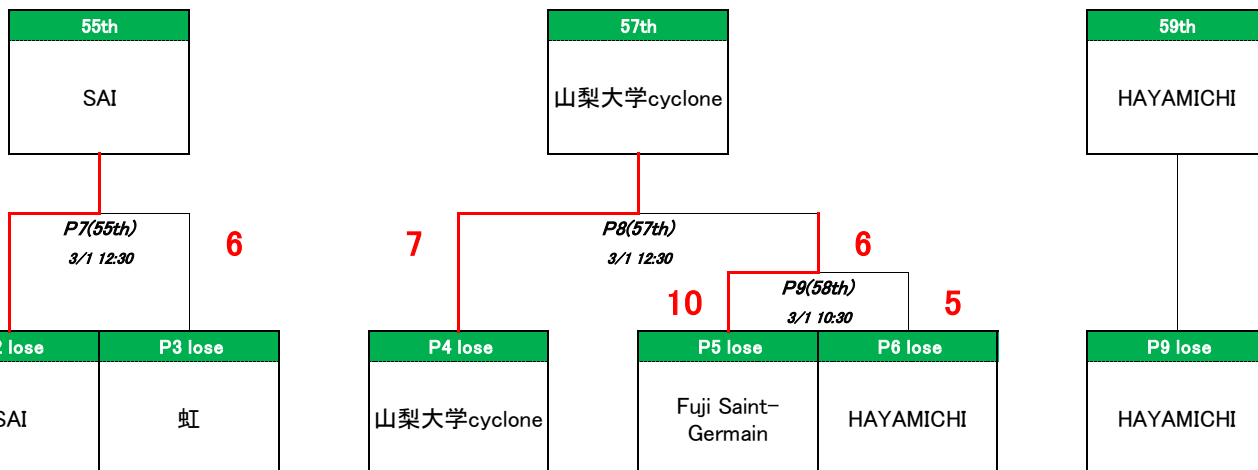
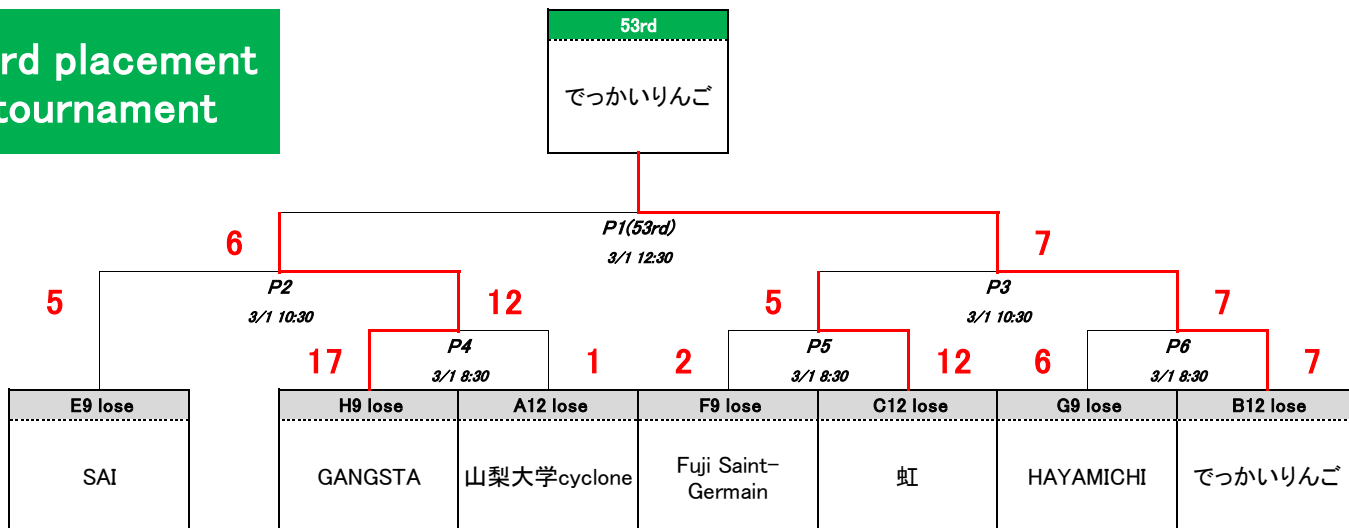

2026 CLUB Jr ULTIMATE DREAM CUP~MIXED DIV.~

FINAL RESULT

Rank	Team name	Rank	Team name	Rank	Team name	Rank	Team name
1st	Shepherds	17th	International Cojicoji_zu	33rd	Baekho	49th	migrant old rookie
2nd	IKU!	18th	Bromance Ultimate	34th	クレッシェンド	50th	MKOG
3rd	JANDLUX	19th	MFD	35th	HappyCampers	51st	Rugoos
4th	SeeKers	20th	Kyotodetox	36th	白川ナイト	52nd	MAHIMAHI
5th	おさつニヨッキ	21st	NANKURU	37th	Killer Whale	53rd	でっかいりんご
6th	MADARA	22nd	GooJoo	38th	北里大学DISPA	54th	GANGSTA
7th	STRANGERS	23rd	SPARKS	39th	Re-roar	55th	SAI
8th	Boar	24th	リベラルアーツ猪股	40th	あさまっく	56th	虹
9th	AMATIAS	25th	BLANK	41st	INDIES	57th	山梨大学cyclone
10th	ODINZ	26th	New York Munchies	42nd	ふかひれ	58th	Fuji Saint-Germain
11th	migrant youth	27th	Aesculus	43rd	VAMOS	59th	HAYAMICHI
12th	Dreamers	28th	JackRussell	44th	ROC-A-AIR		
13th	GORAIKOH	29th	たんきち	45th	とび魚バタフライ3		
14th	KURU	30th	ECLIPSE	46th	東京学芸大学 BIGAPPLE		
15th	CHATONS	31st	国土無双	47th	Swift Harmony		
16th	Voladores	32nd	RELAX	48th	HUF		
Rank	Individual award						
MVP	伊藤 綾香 選手 (Shepherds 所属)						
Fighting-spirit award	佐川 公太 選手 (IKU! 所属)						

2026 CLUB Jr ULTIMATE DREAM CUP / OPEN DIV.
Qualifying tournament

Tournament A

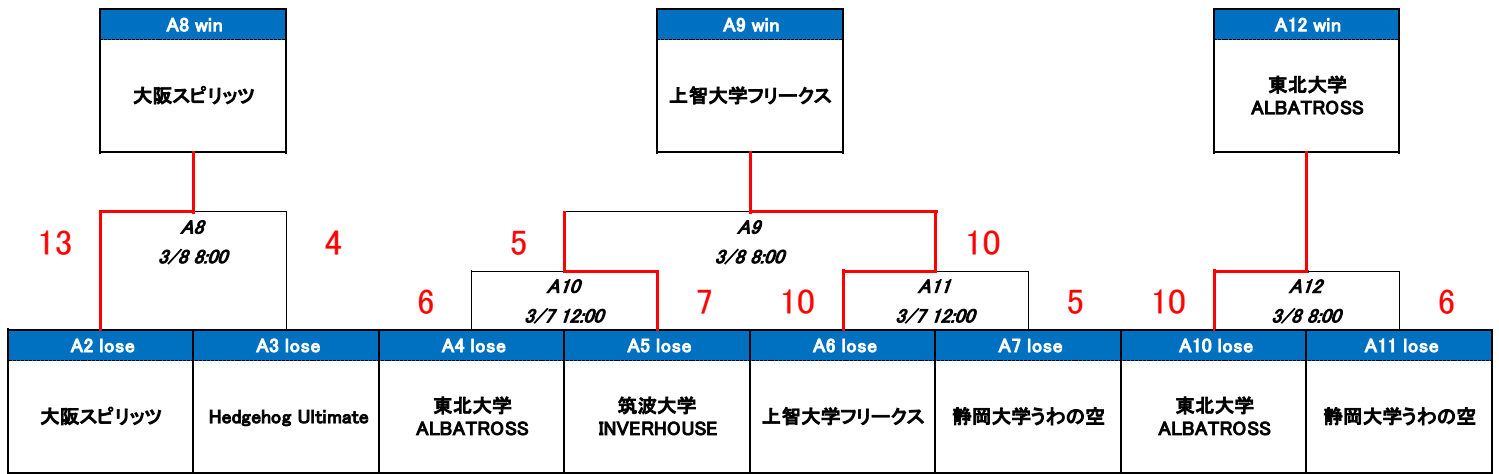
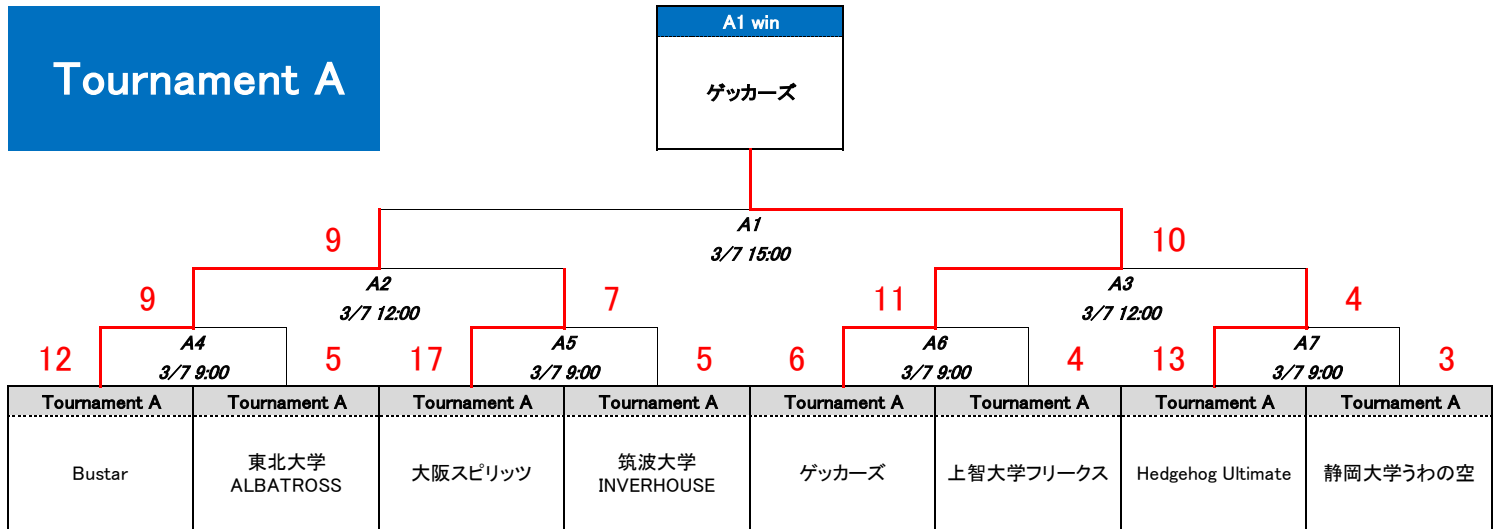

Tournament B

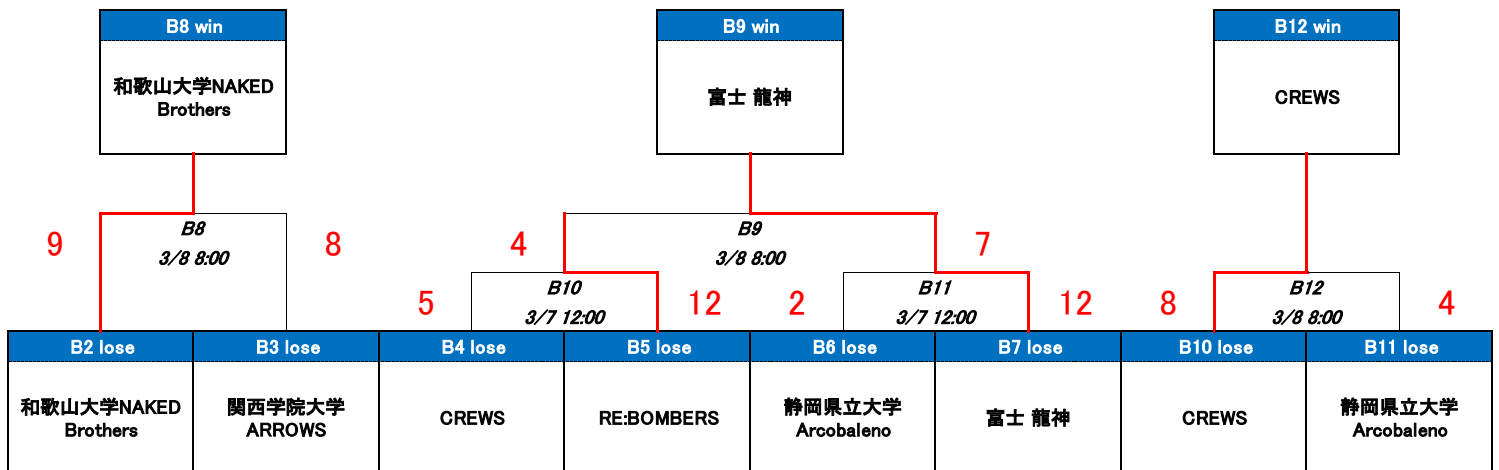
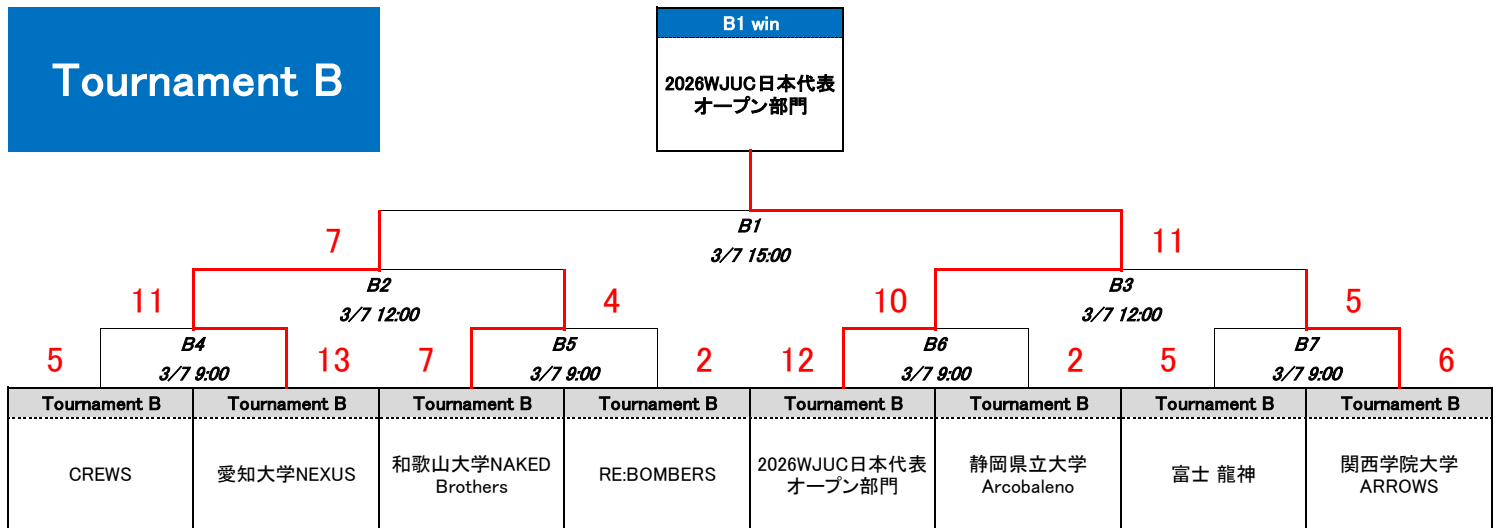

2026 CLUB Jr ULTIMATE DREAM CUP/OPEN DIV.
Qualifying tournament

Tournament C

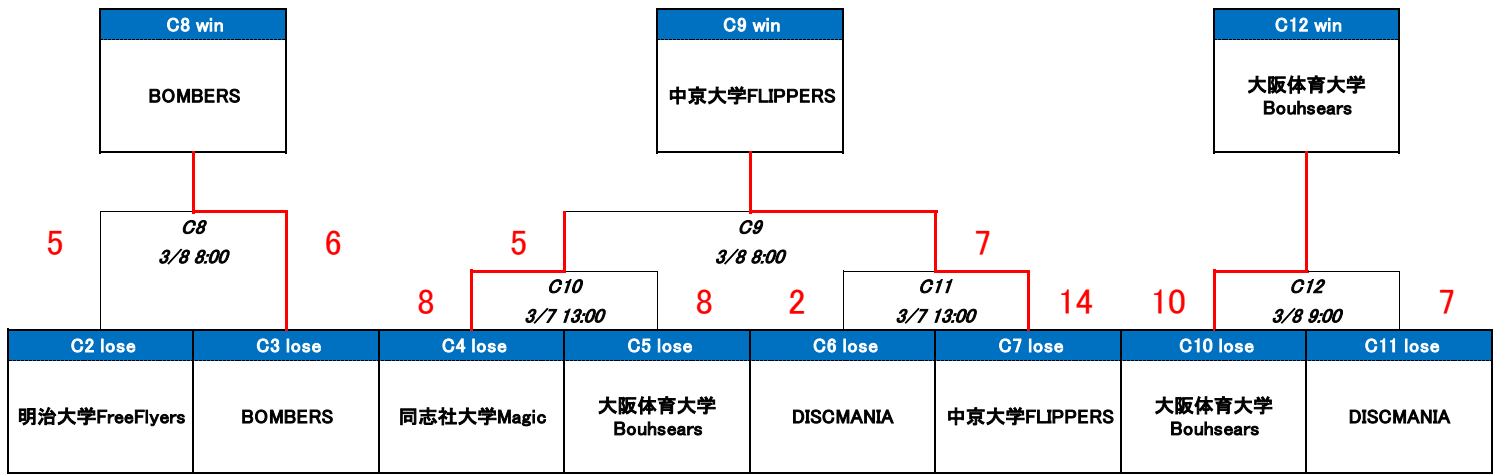
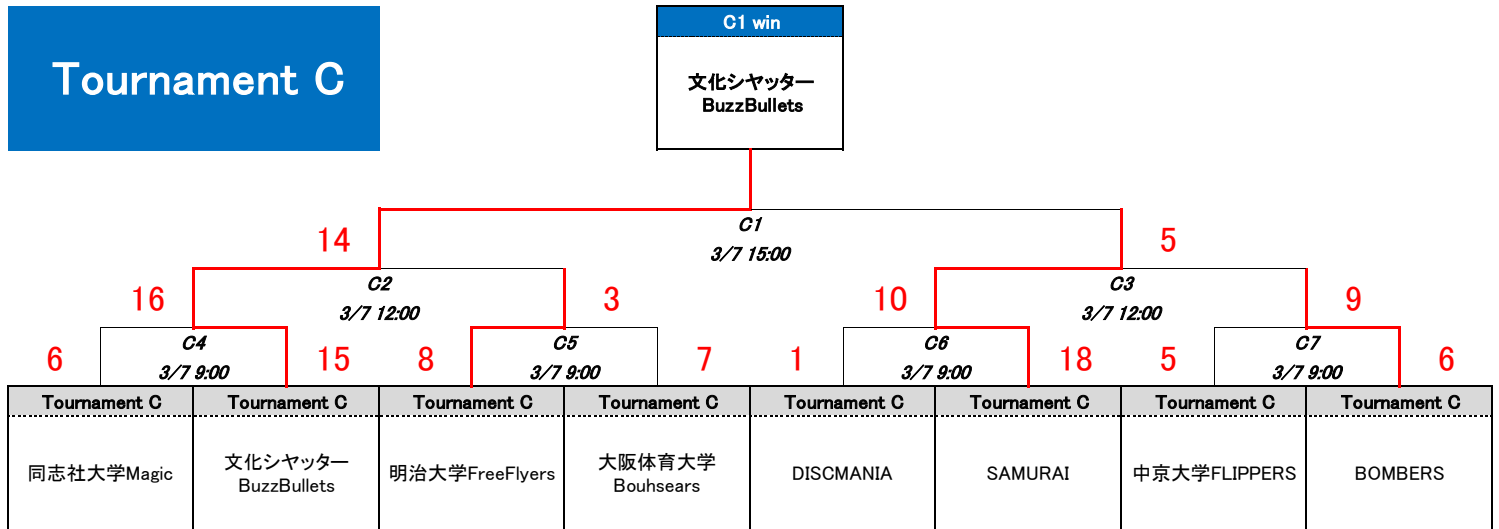

Tournament D

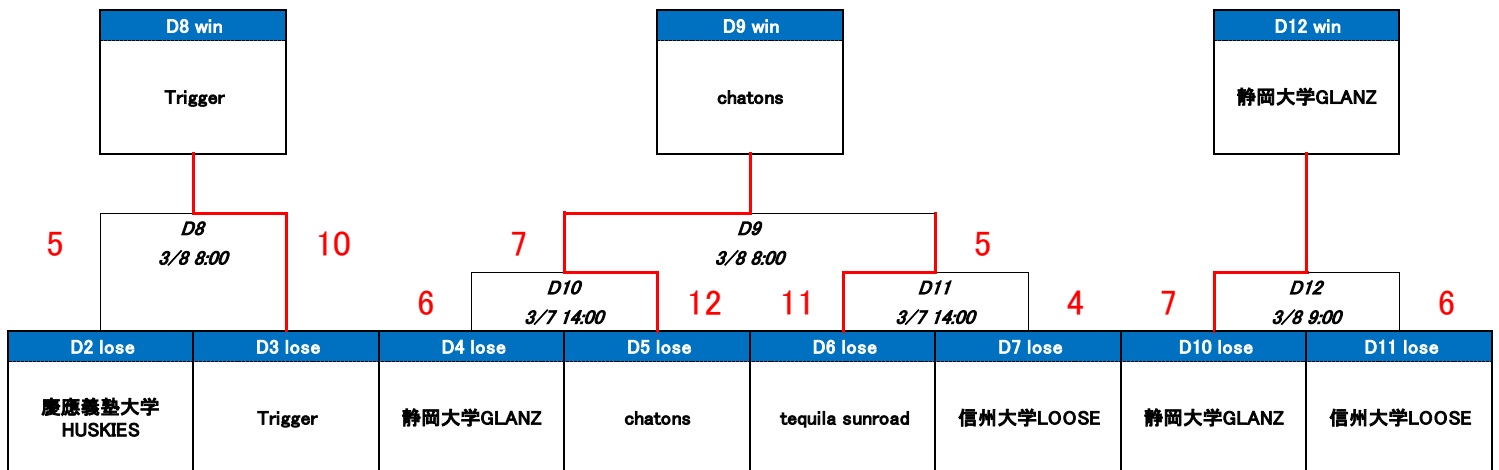
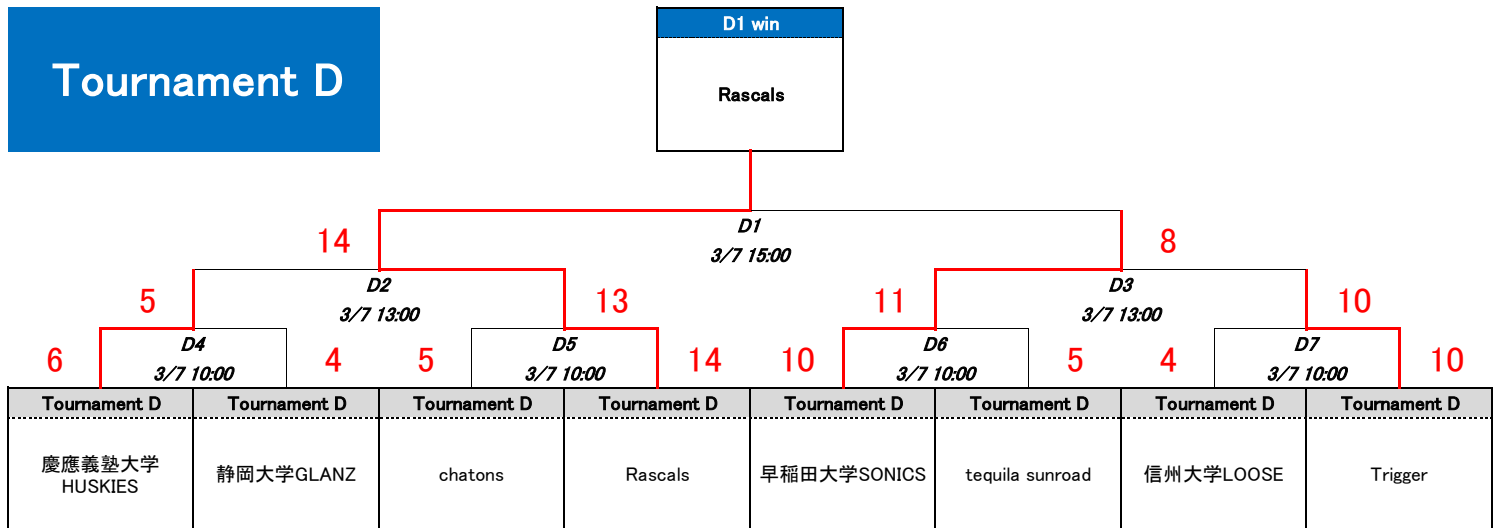

2026 CLUB Jr ULTIMATE DREAM CUP / OPEN DIV.
Qualifying tournament

Tournament E

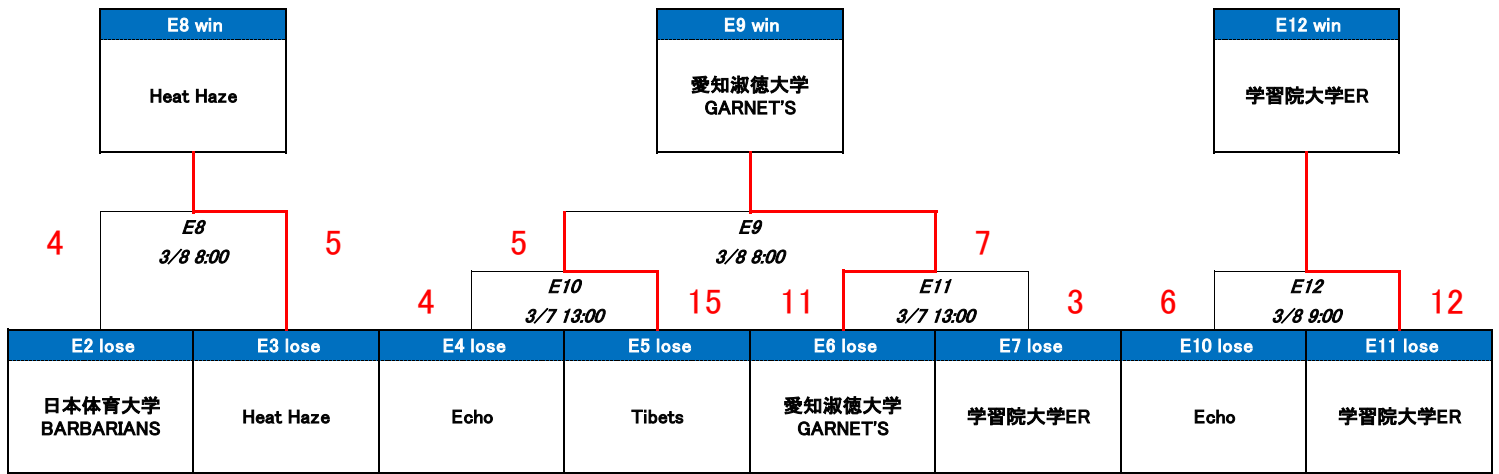
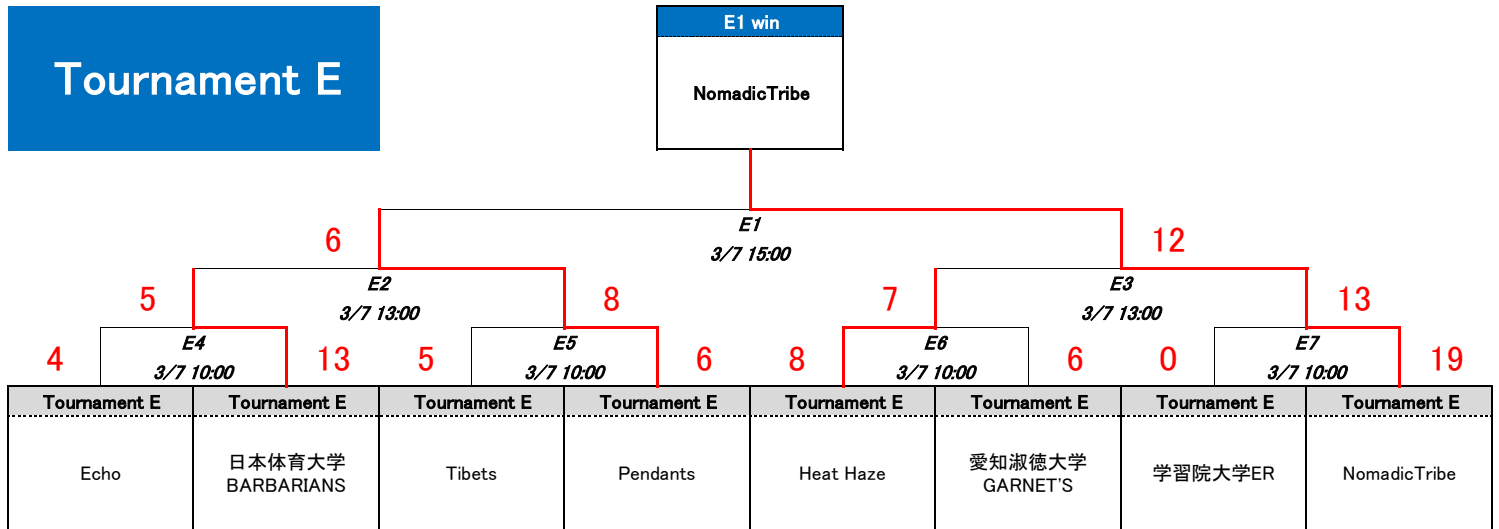

Tournament F

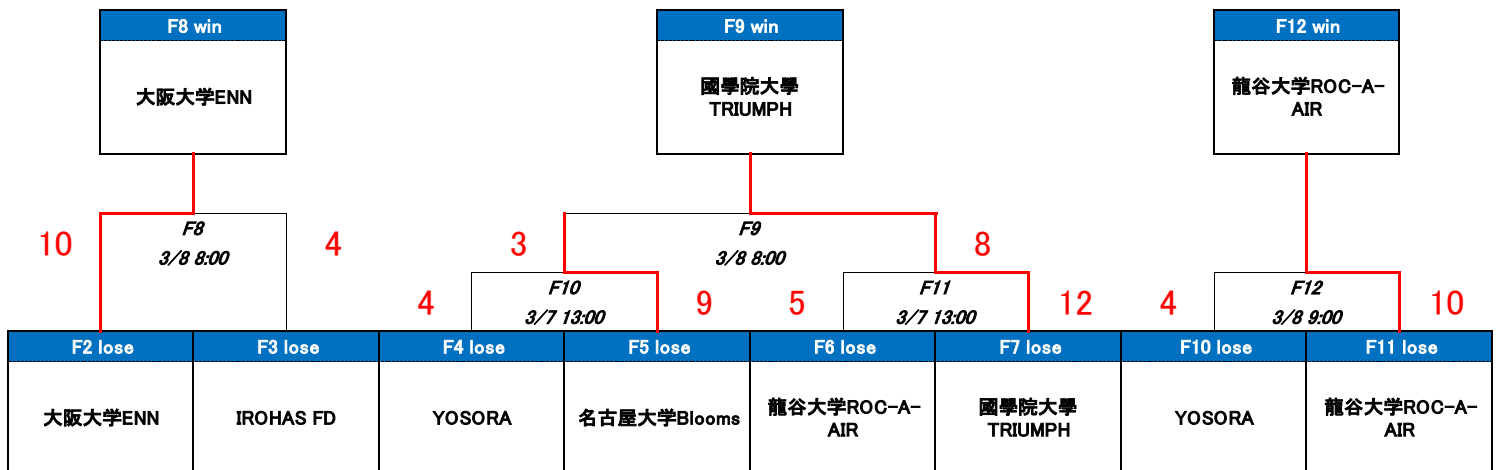
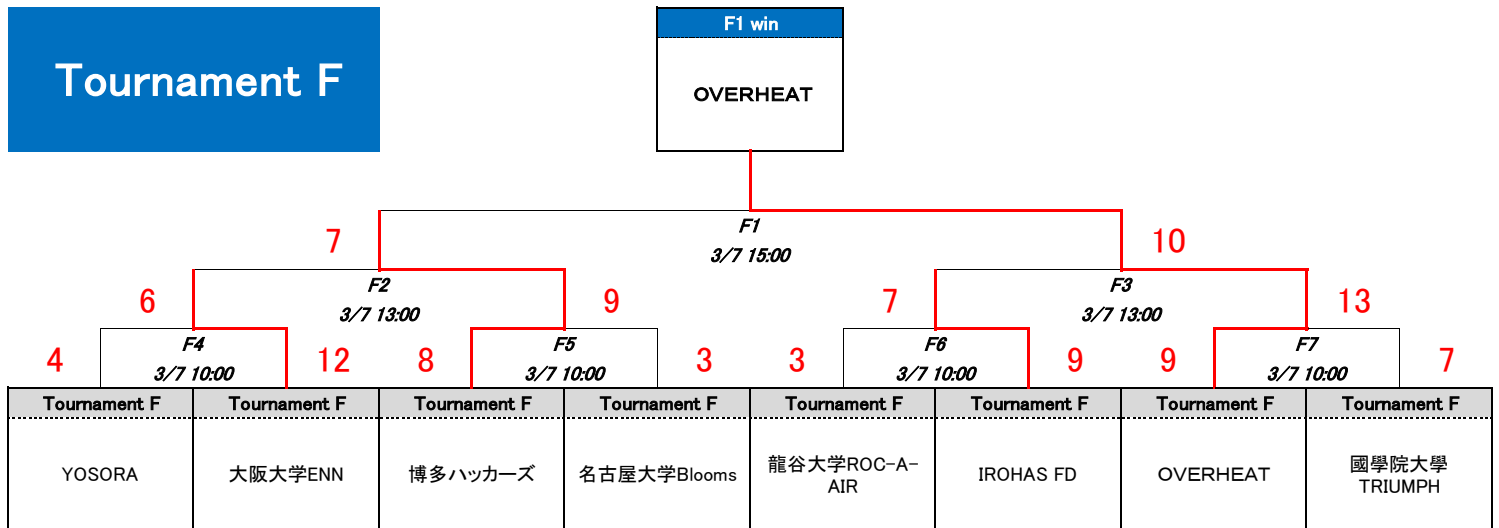

2026 CLUB Jr ULTIMATE DREAM CUP / OPEN DIV.
Qualifying tournament

Tournament G

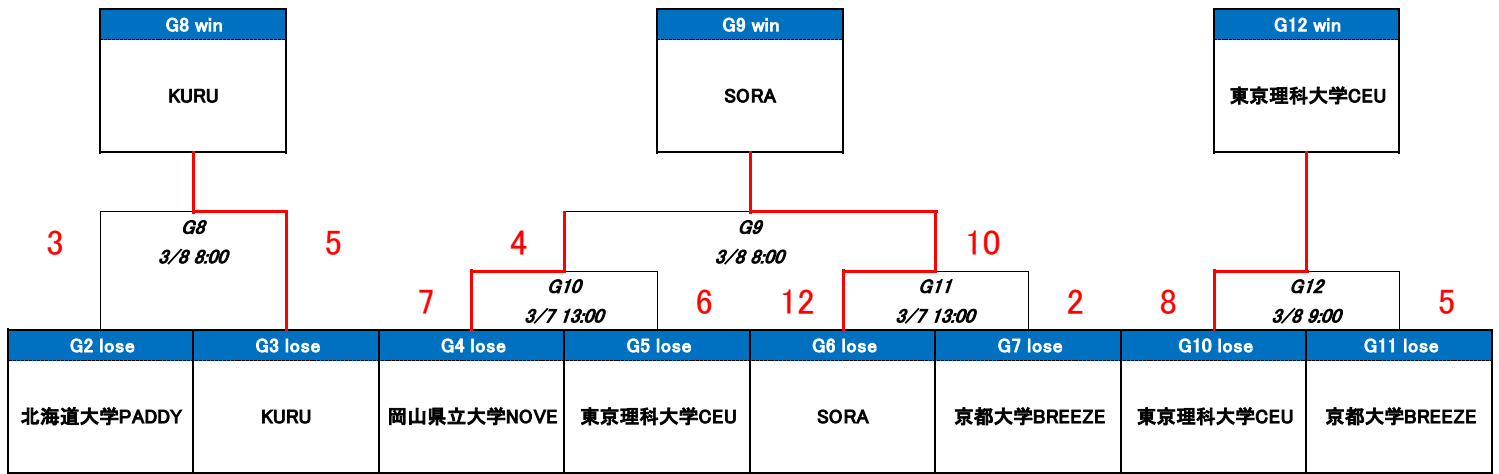
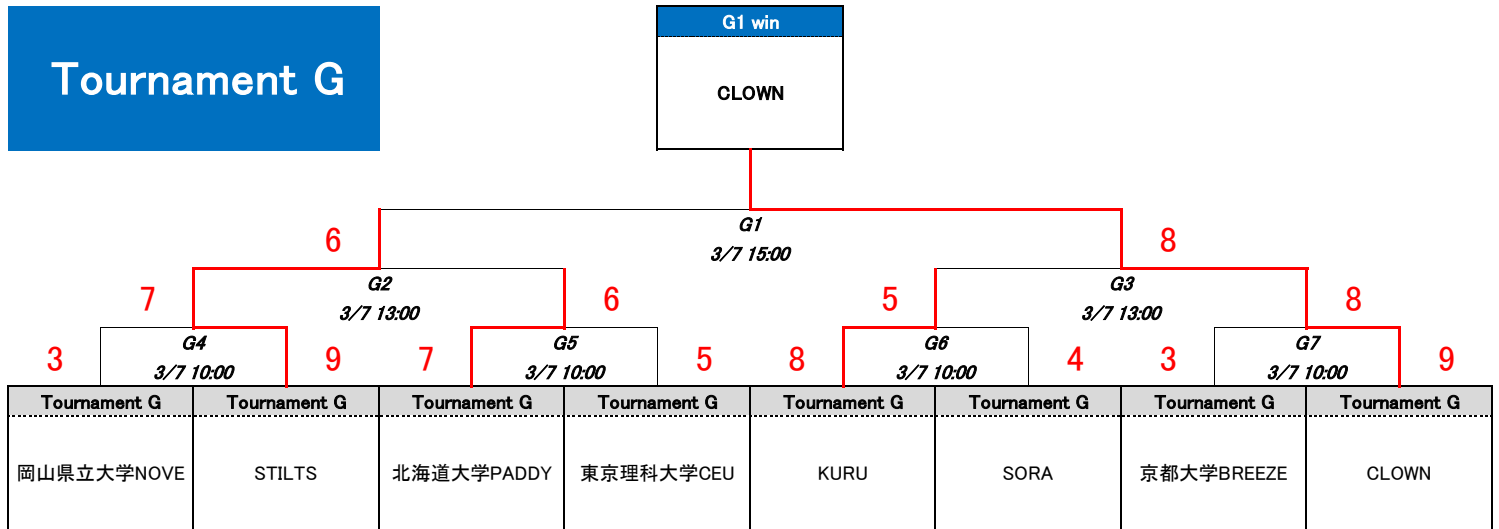

Tournament H

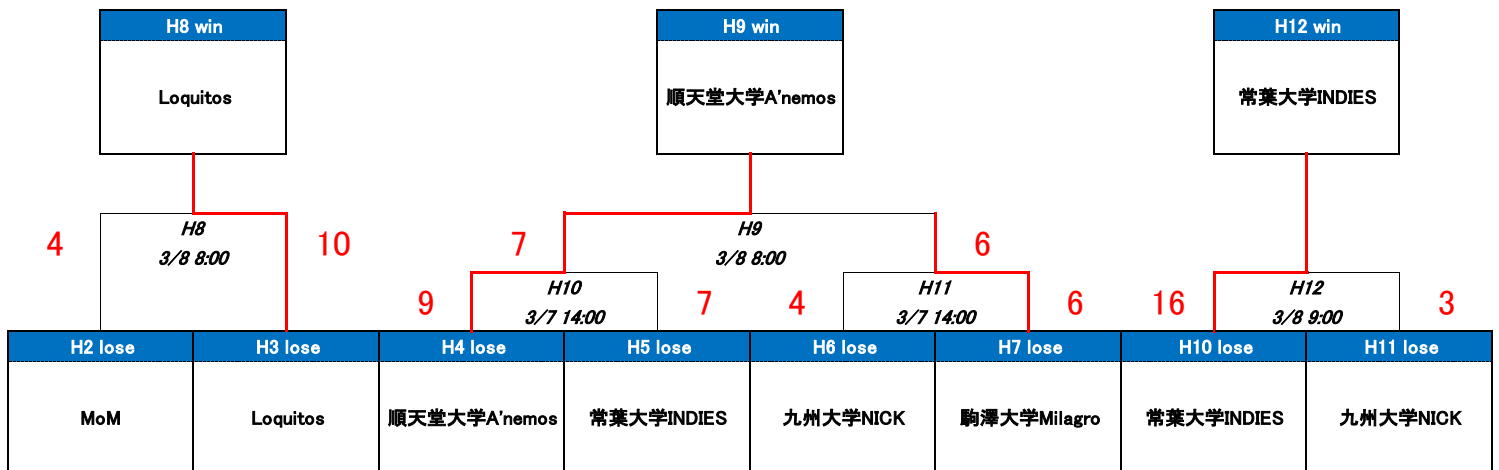
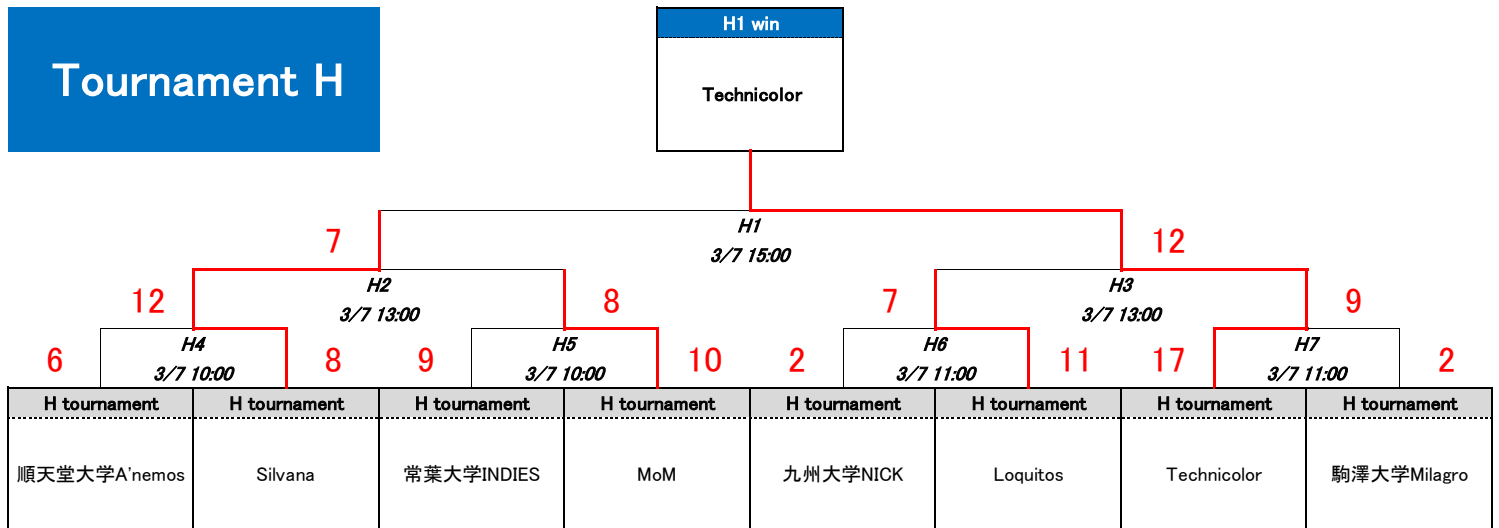

2026 CLUB Jr ULTIMATE DREAM CUP / OPEN DIV.
Championship tournament

Championship
tournament

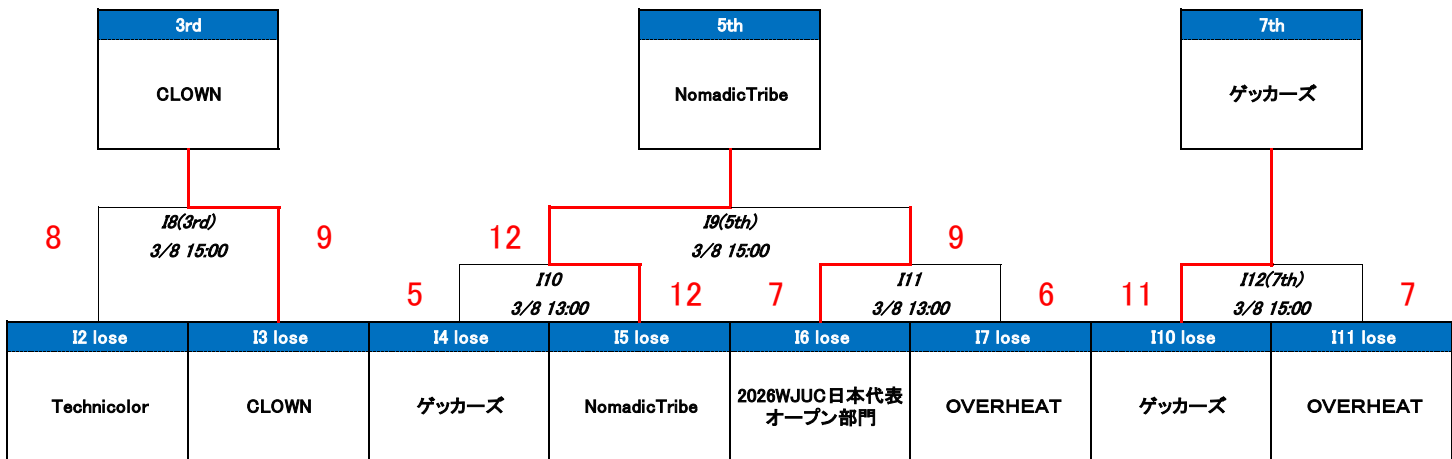
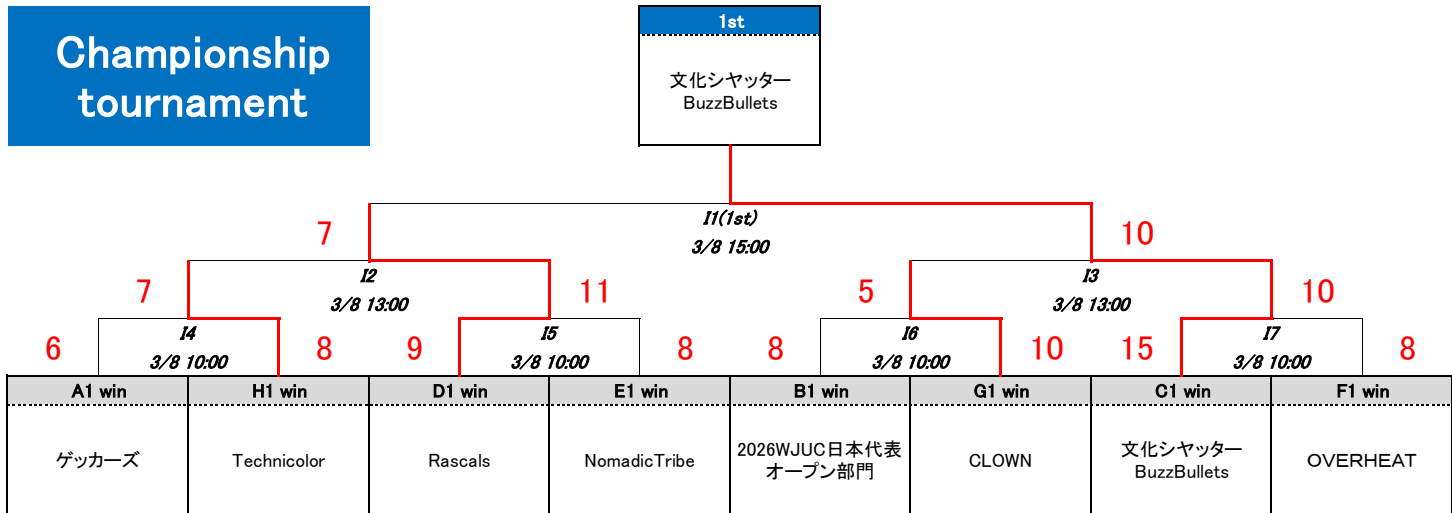

9th placement
tournament

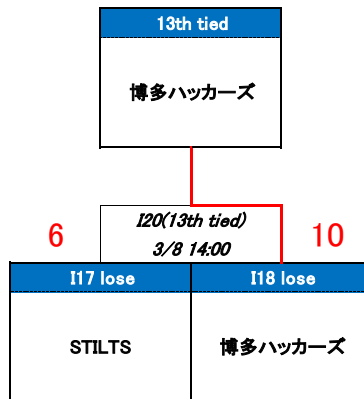
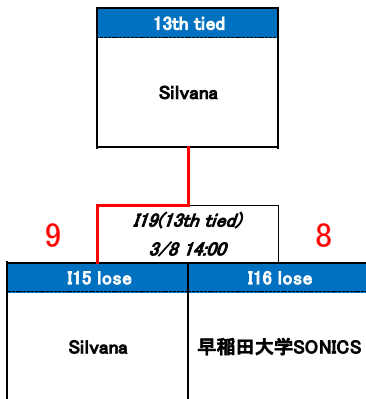
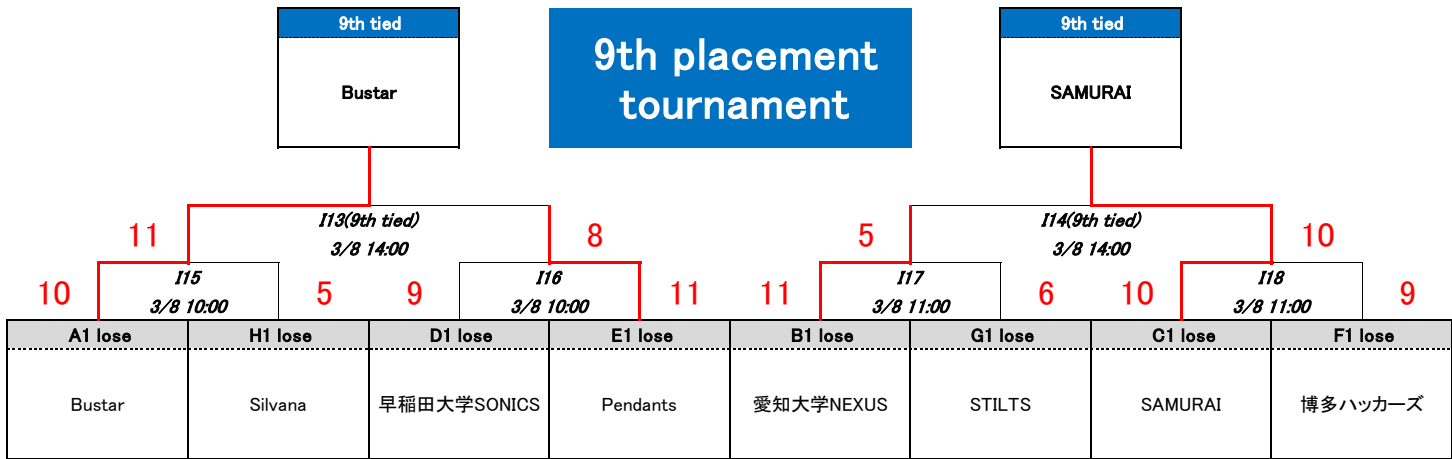

2026 CLUB Jr ULTIMATE DREAM CUP / OPEN DIV.
Championship tournament

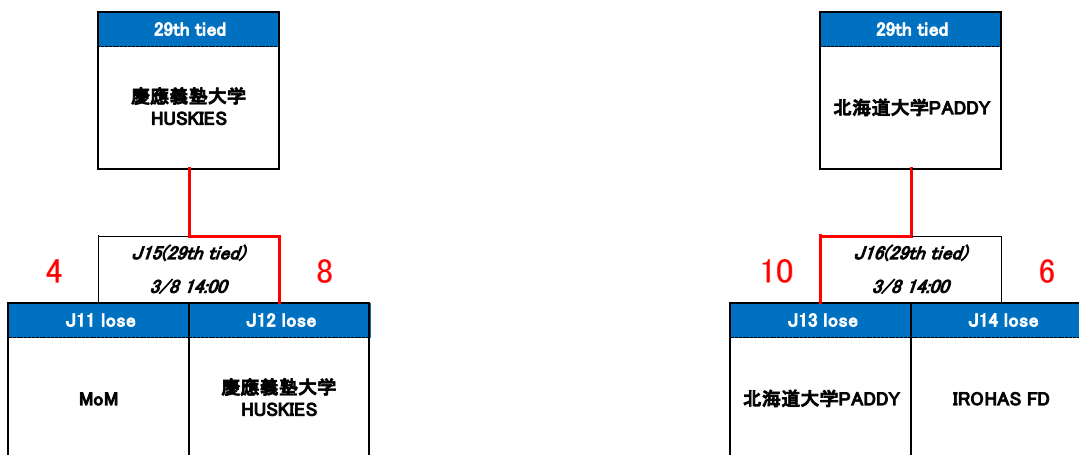
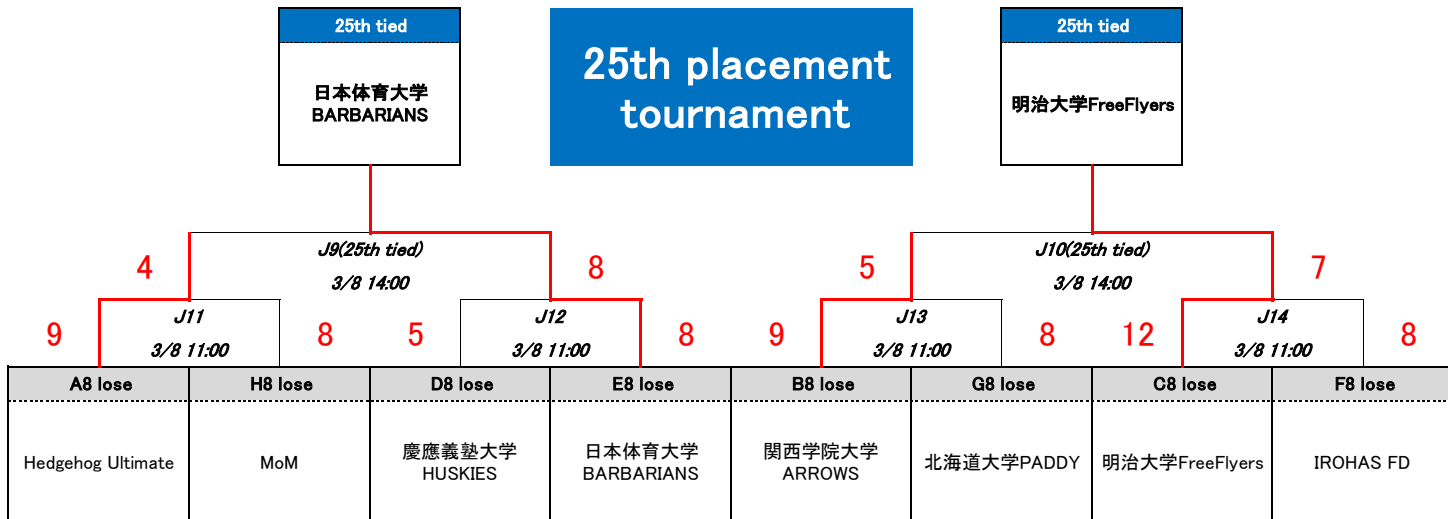
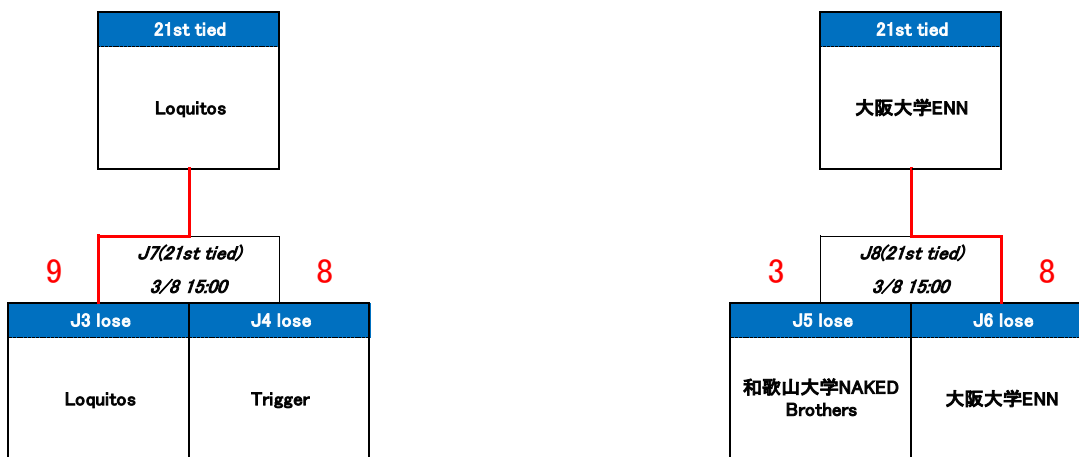
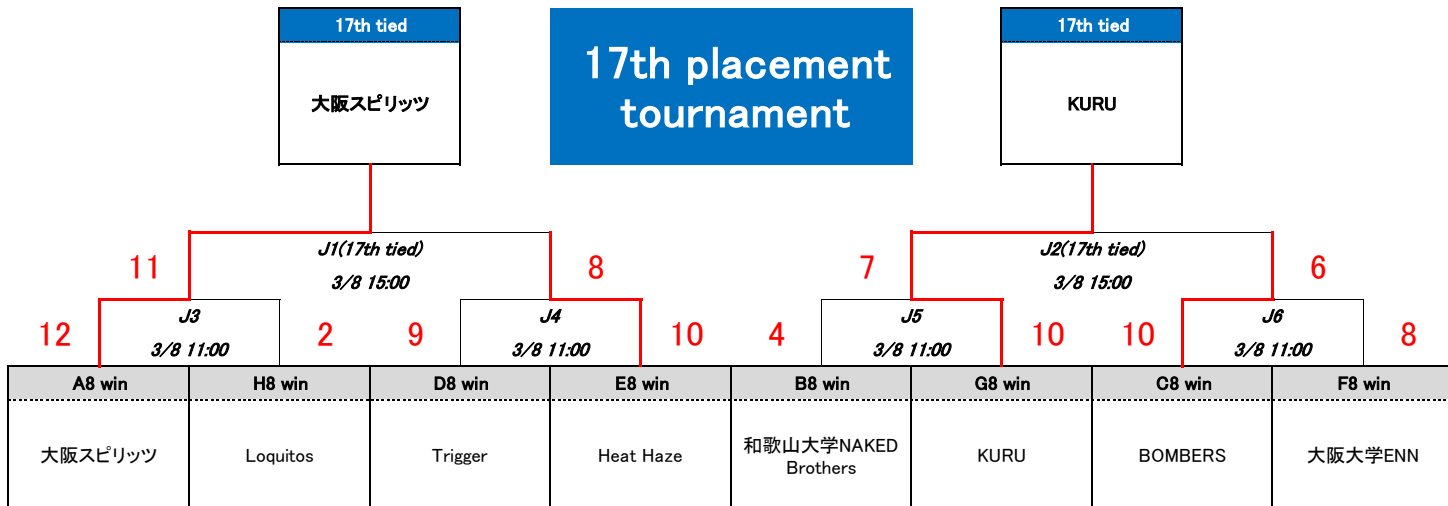

2026 CLUB Jr ULTIMATE DREAM CUP / OPEN DIV.
Championship tournament

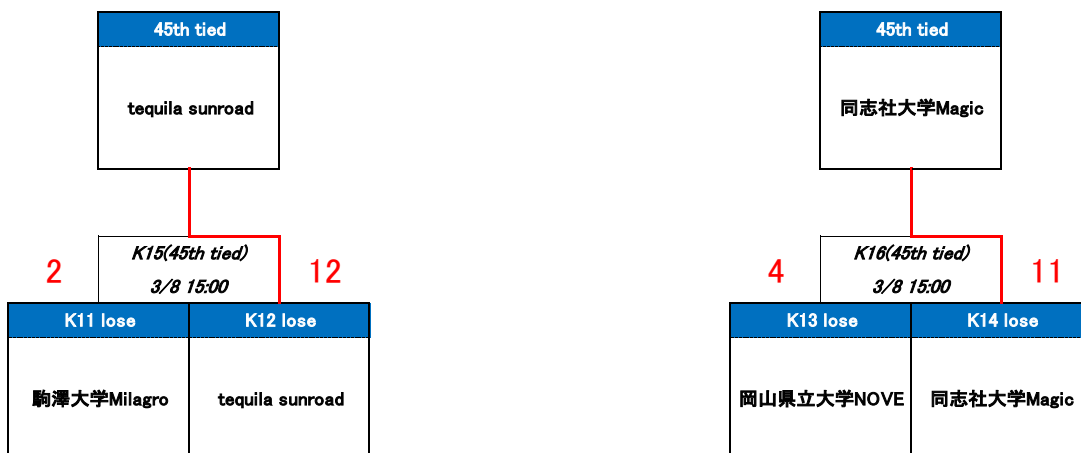
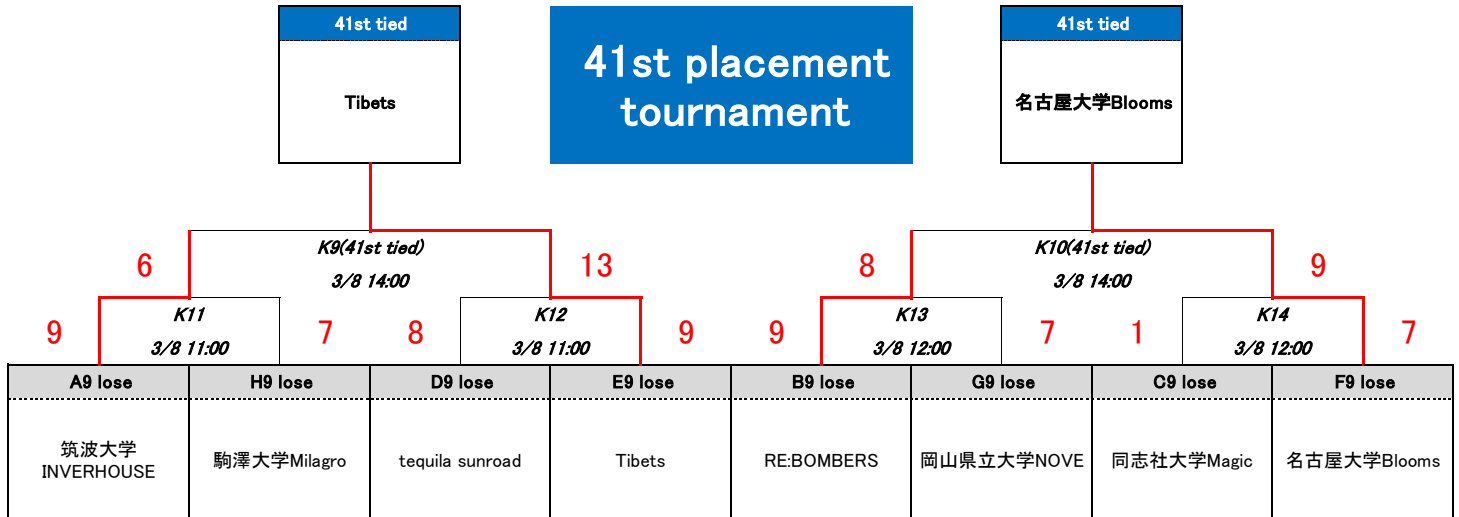
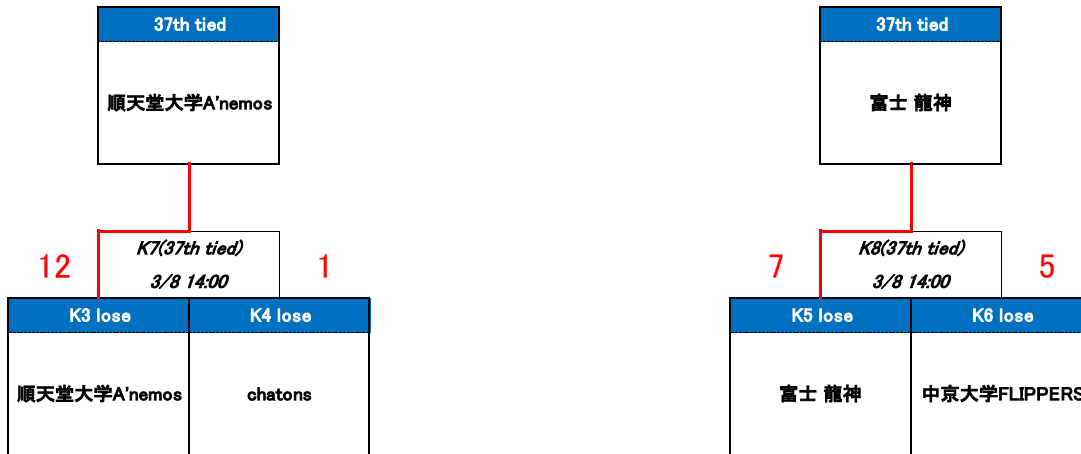
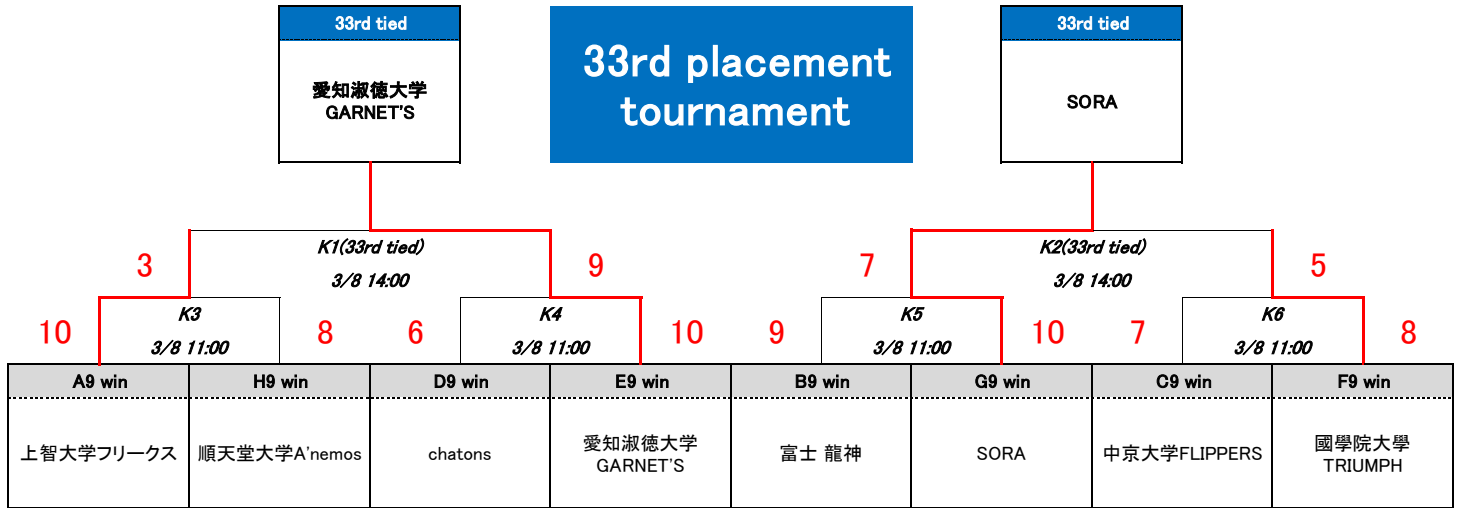

2026 CLUB Jr ULTIMATE DREAM CUP / OPEN DIV.
Championship tournament

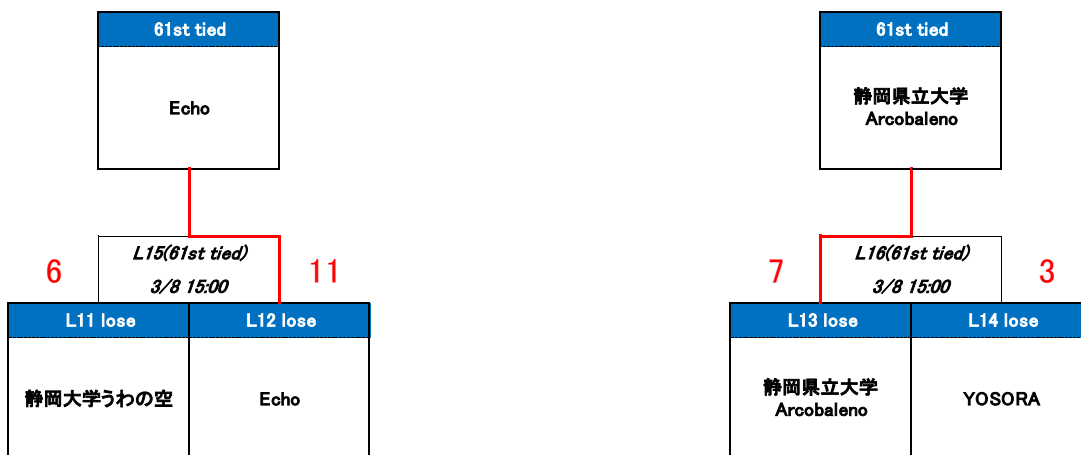
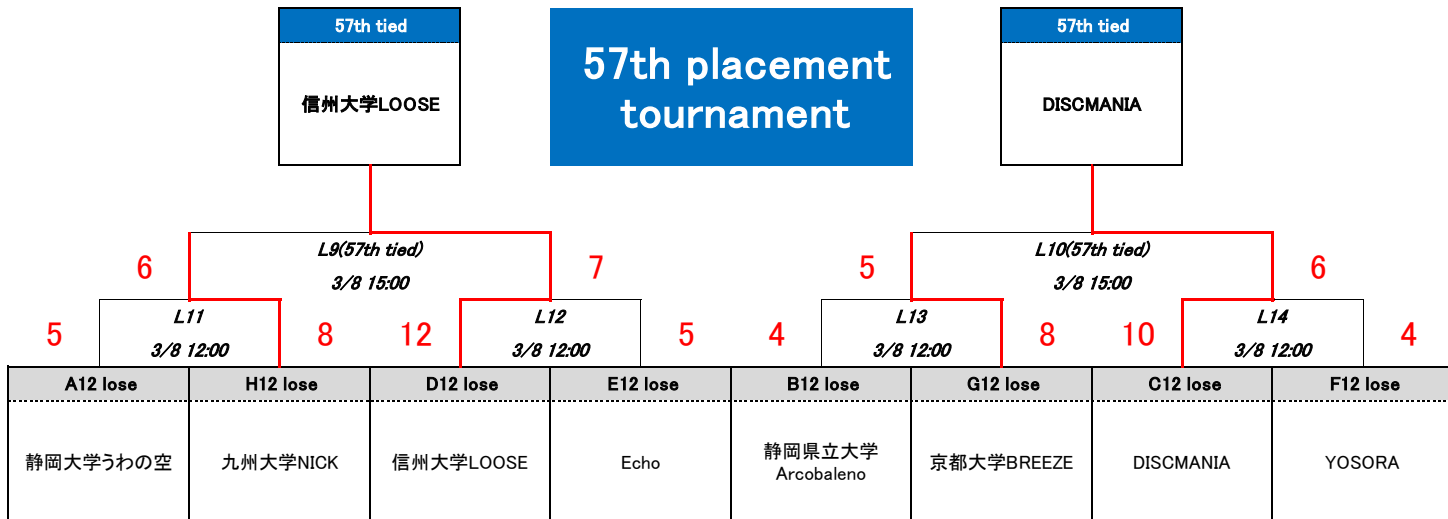
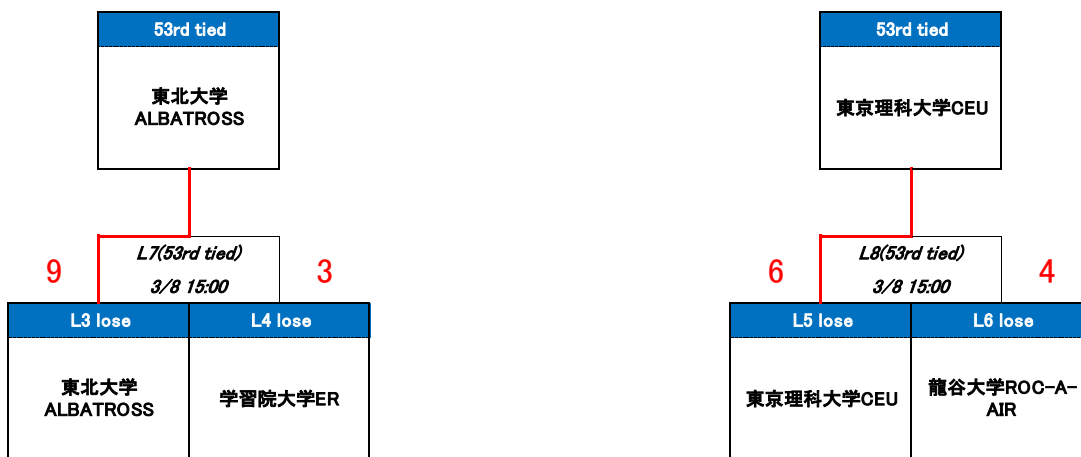
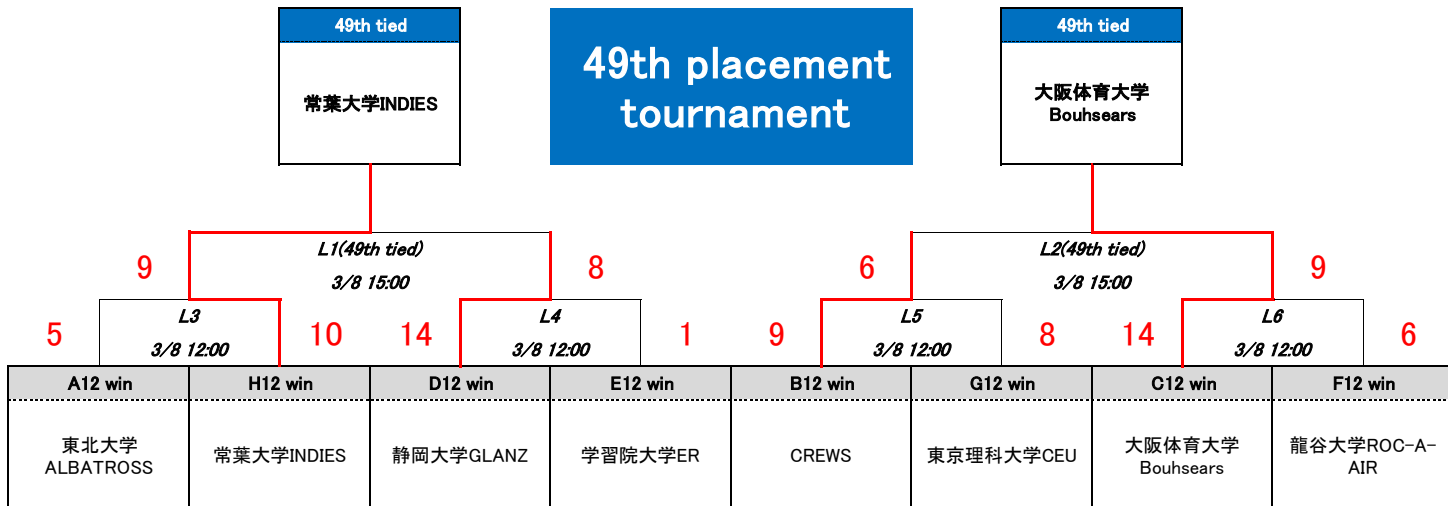

2026 CLUB Jr ULTIMATE DREAM CUP / WOMEN'S DIV.
Qualifying tournament

Tournament M

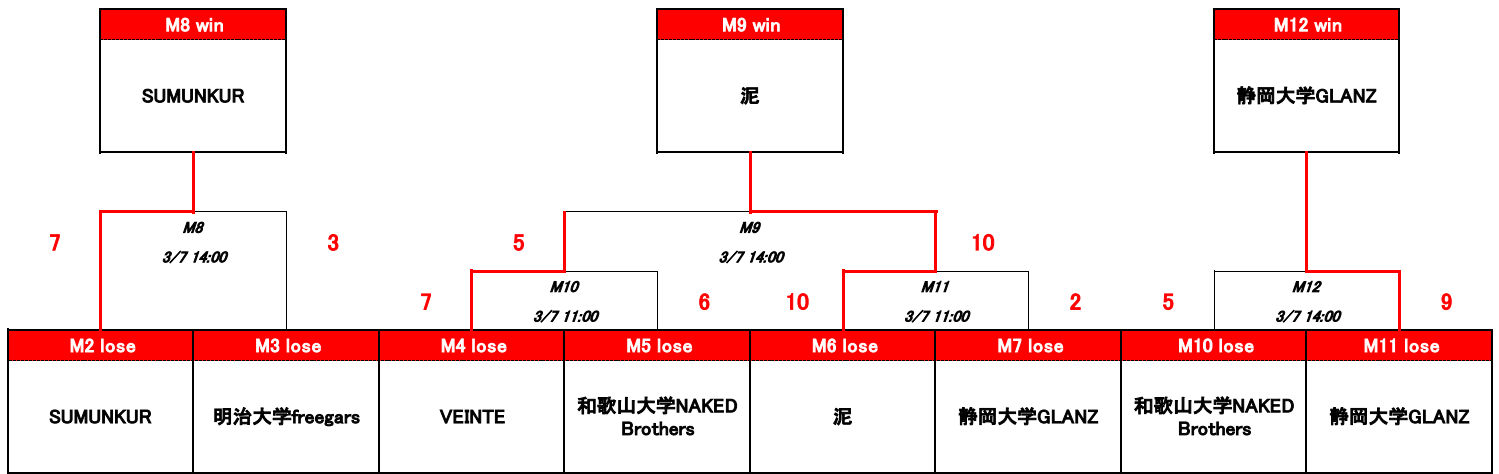
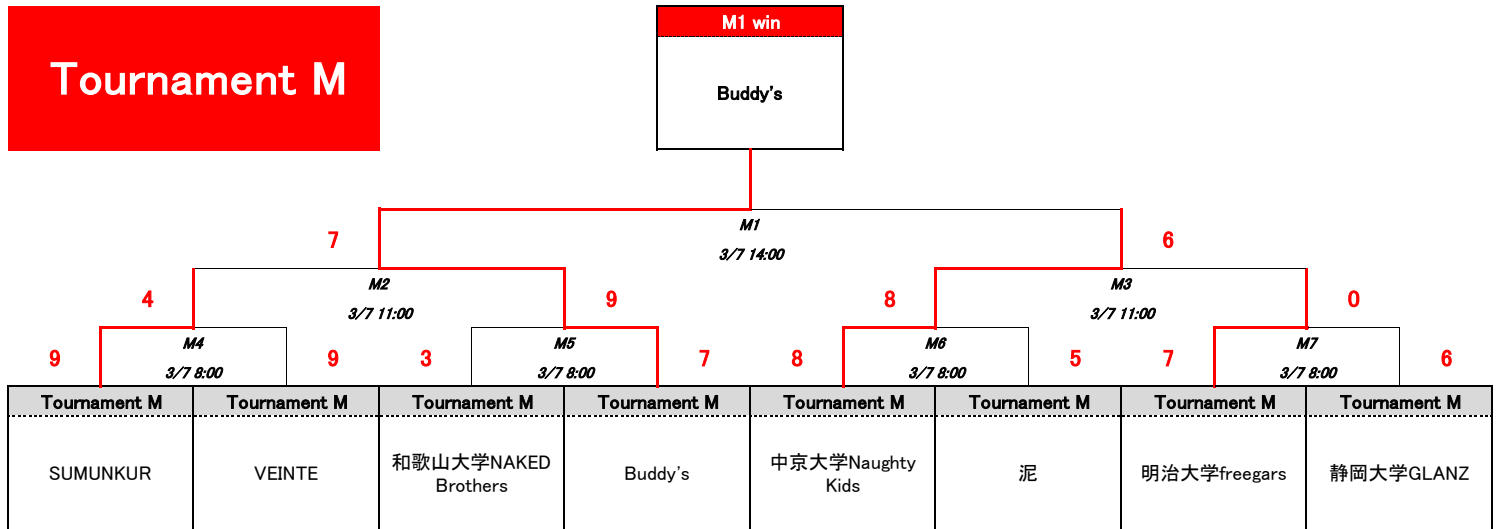

Tournament N

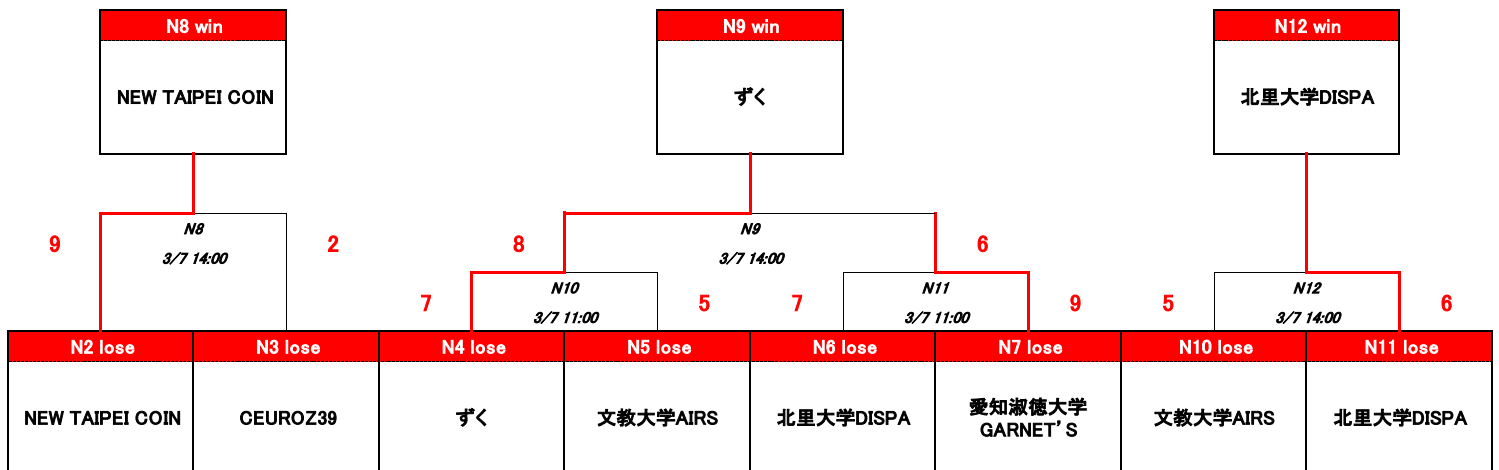
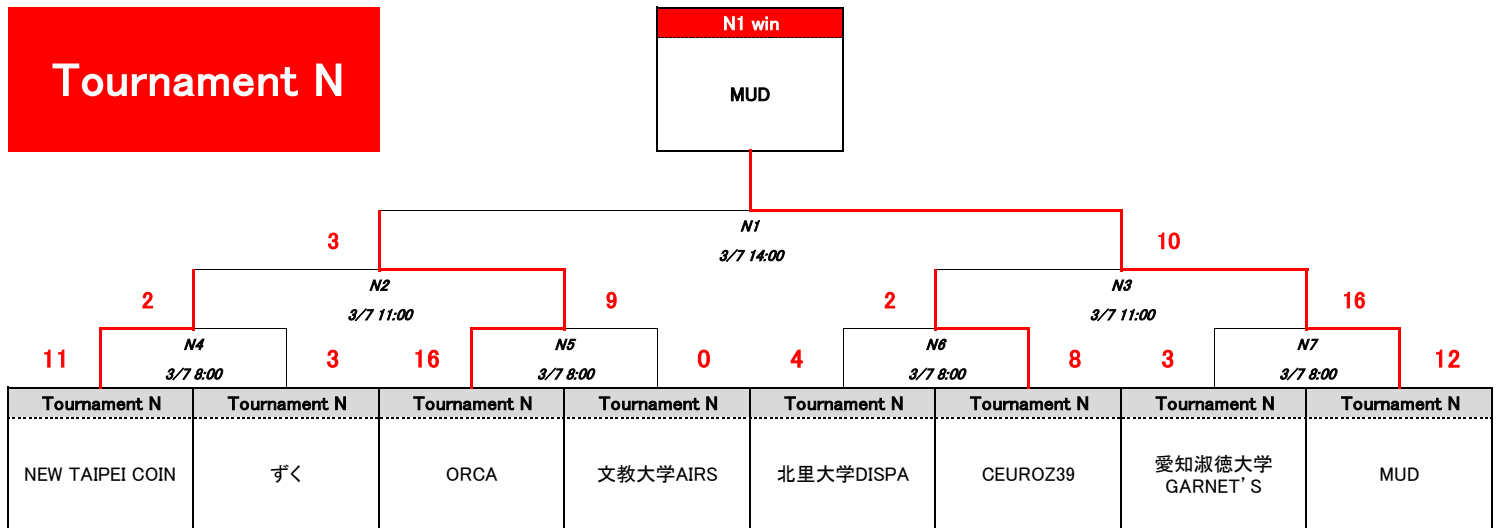

2026 CLUB Jr ULTIMATE DREAM CUP / WOMEN'S DIV.
Qualifying tournament

Tournament O

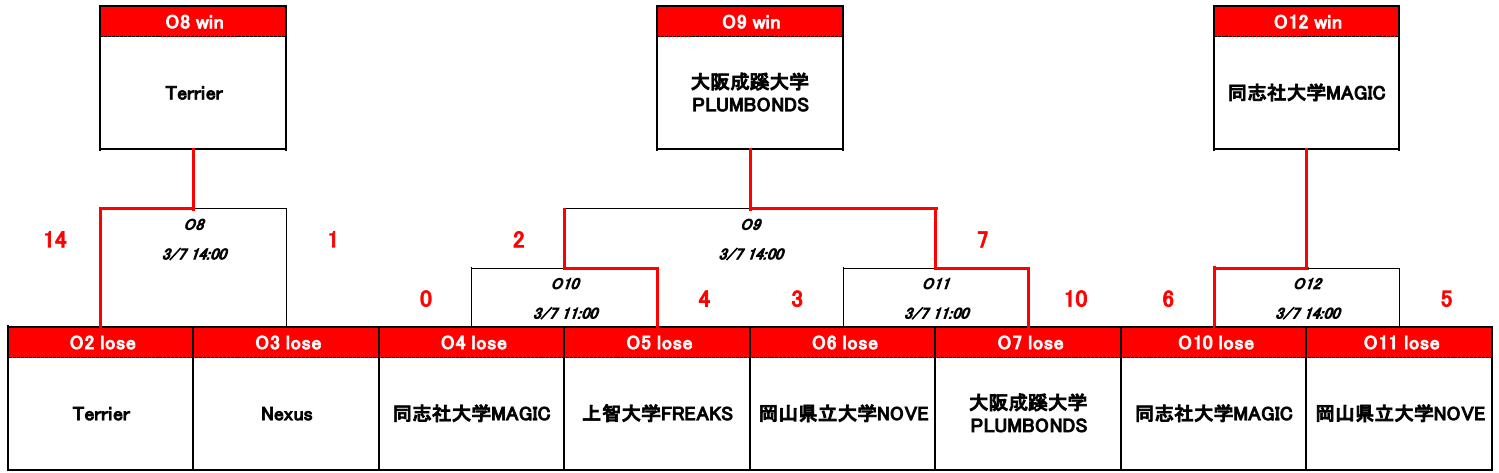
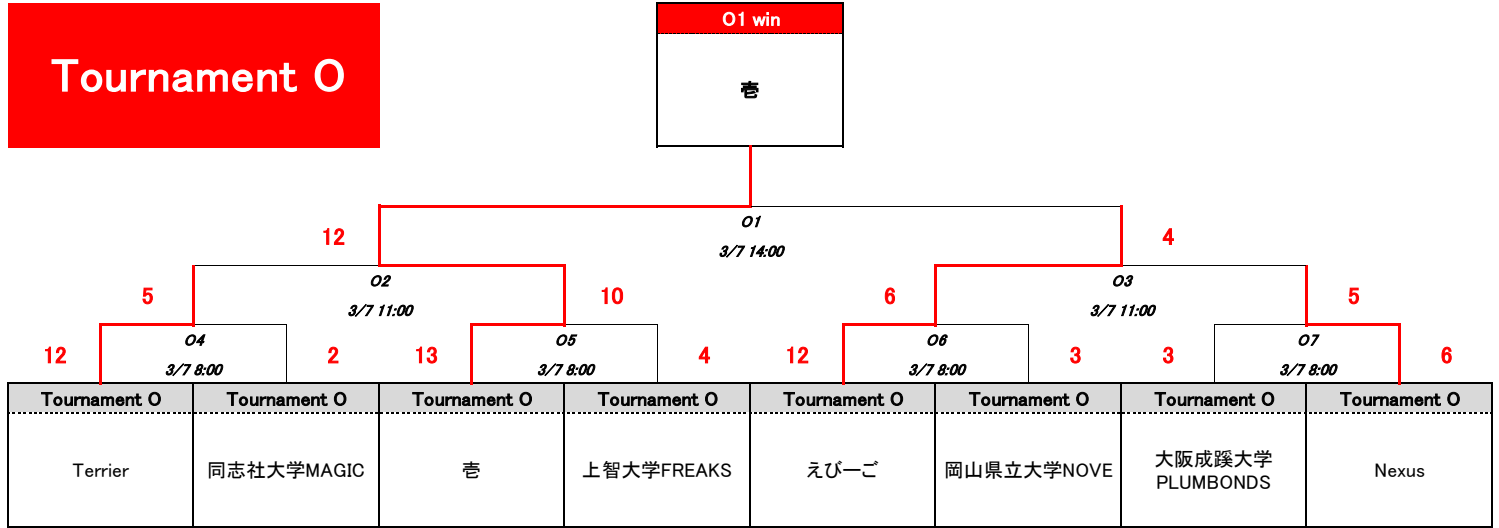

Tournament P

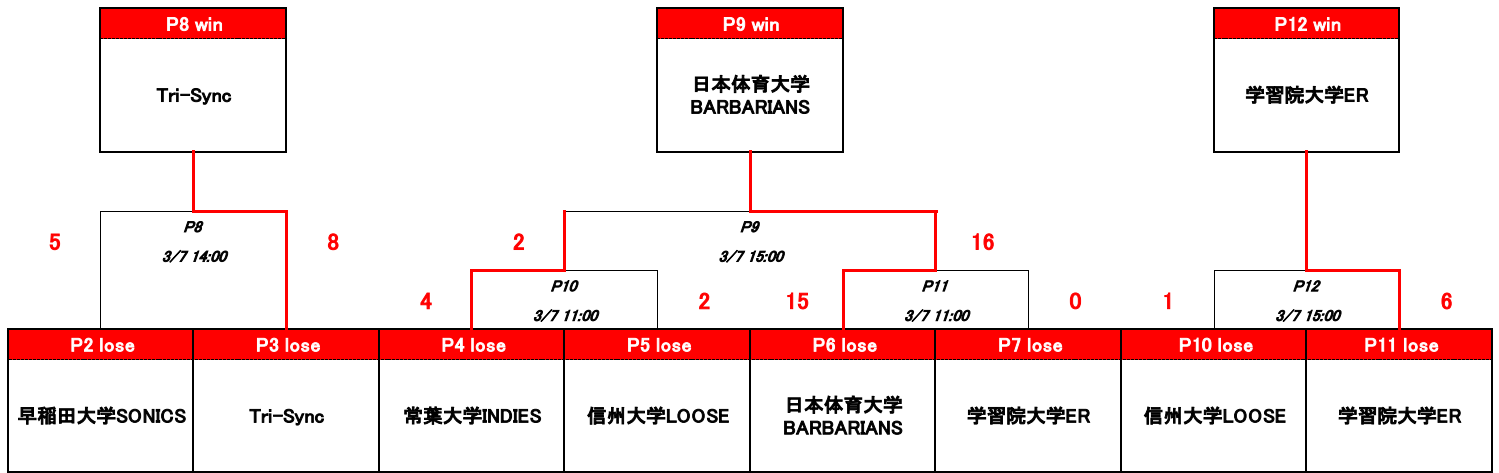
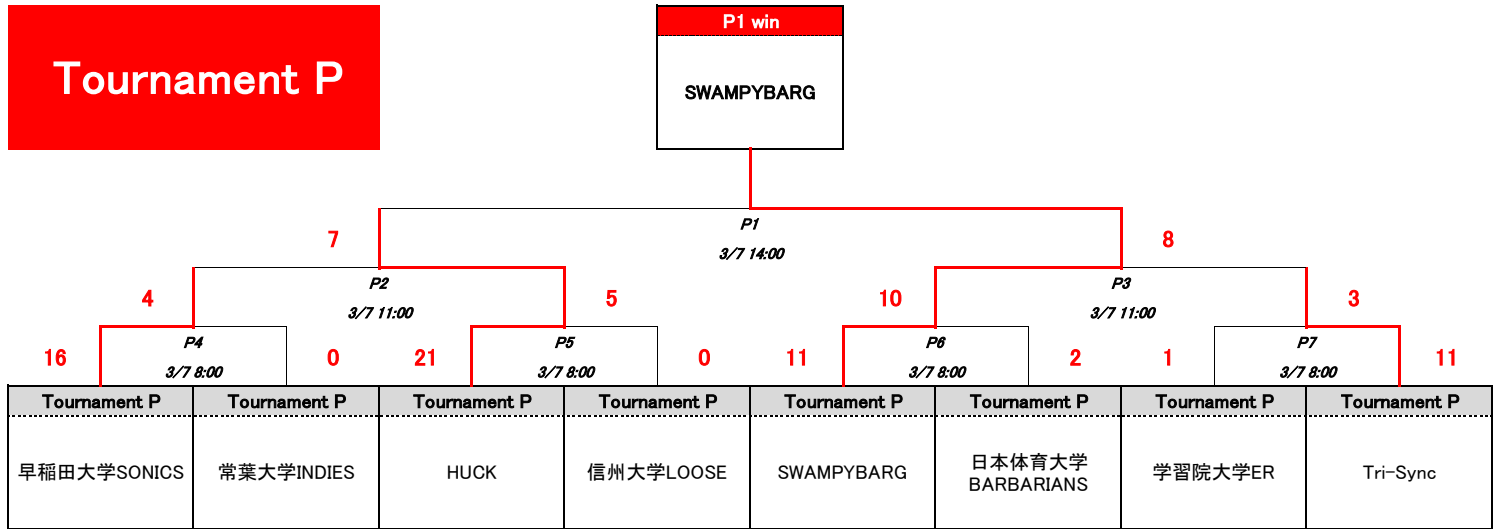

2026 CLUB Jr ULTIMATE DREAM CUP / WOMEN'S DIV.
Qualifying tournament

Tournament Q

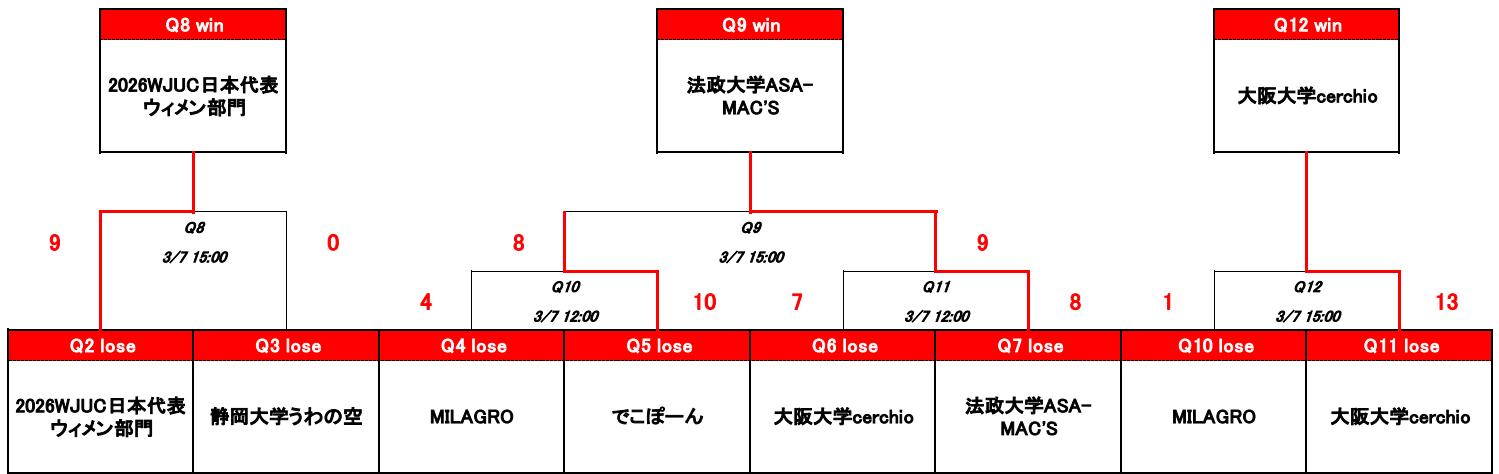
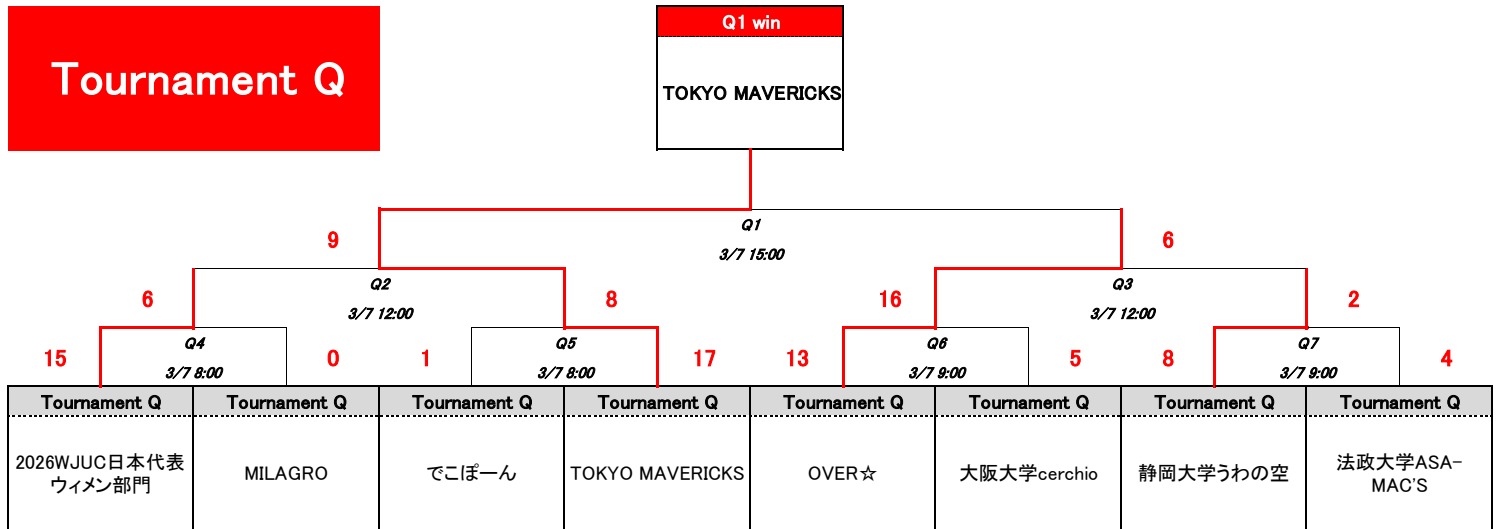

Tournament R

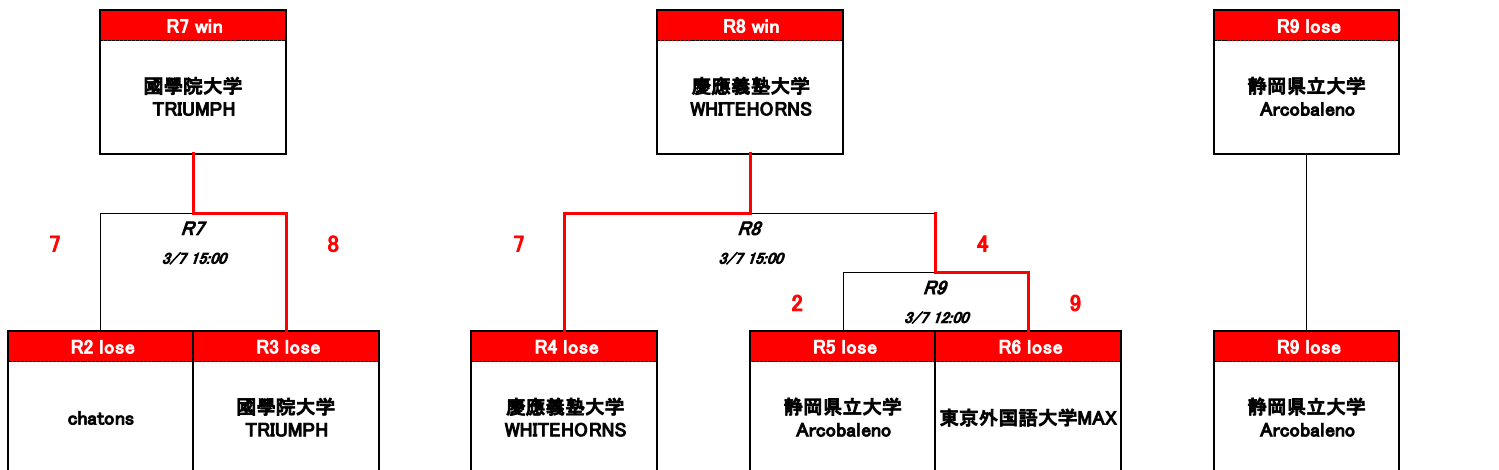
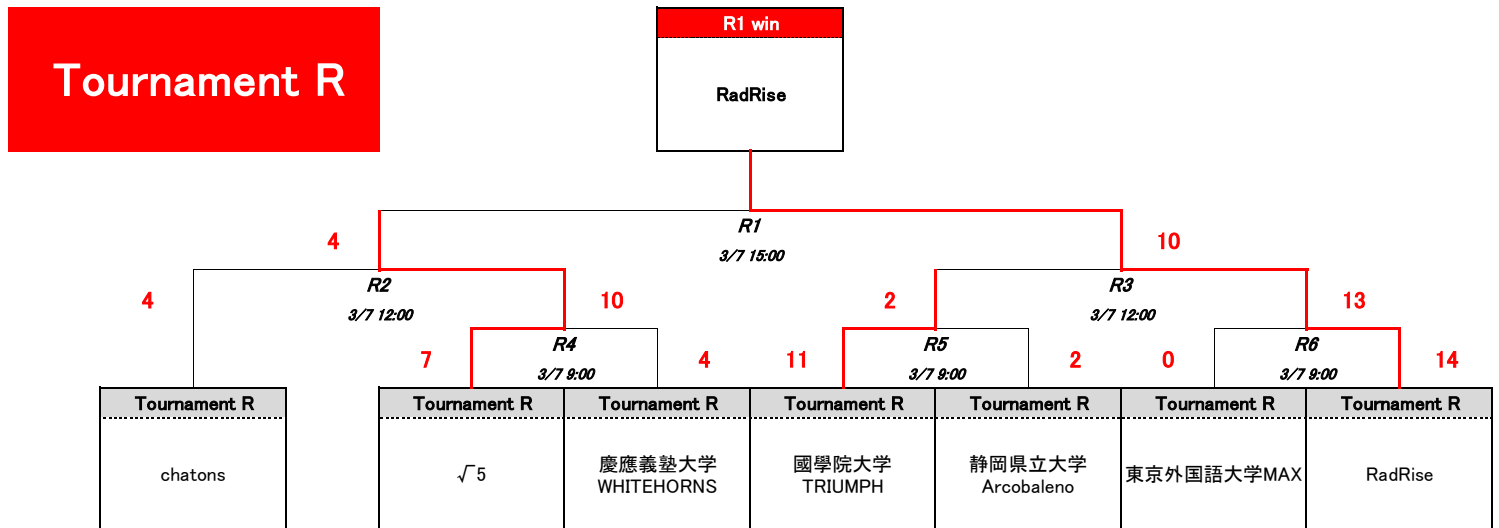

2026 CLUB Jr ULTIMATE DREAM CUP / WOMEN'S DIV.
Championship tournament

Championship
tournament

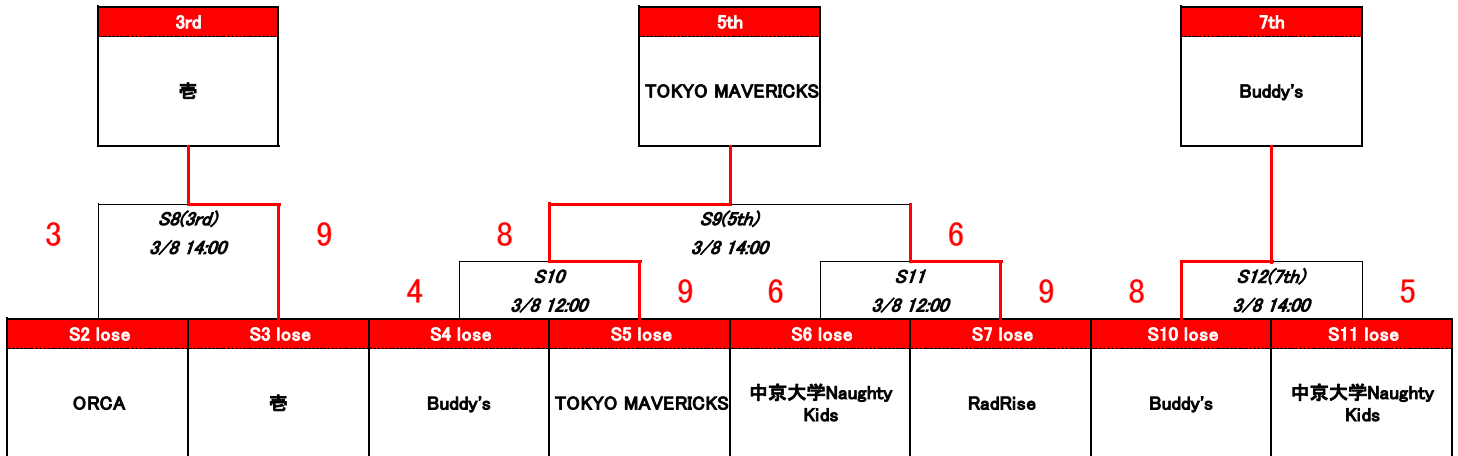
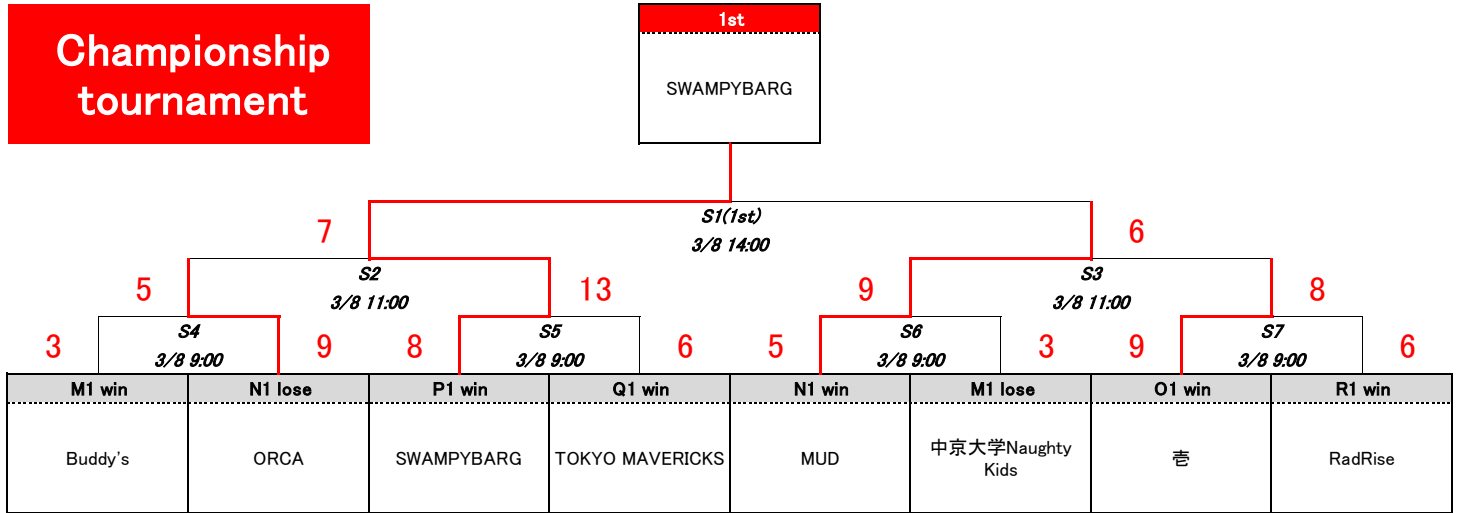

9th placement
tournament

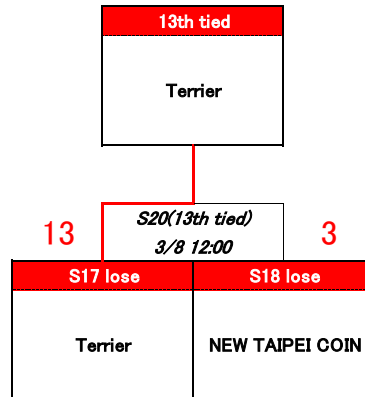
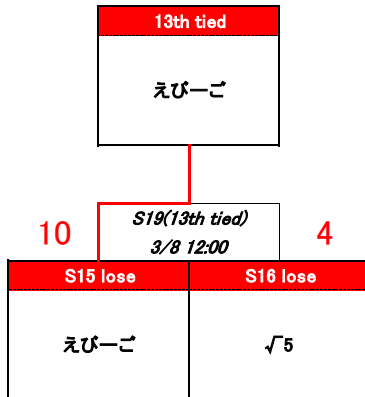
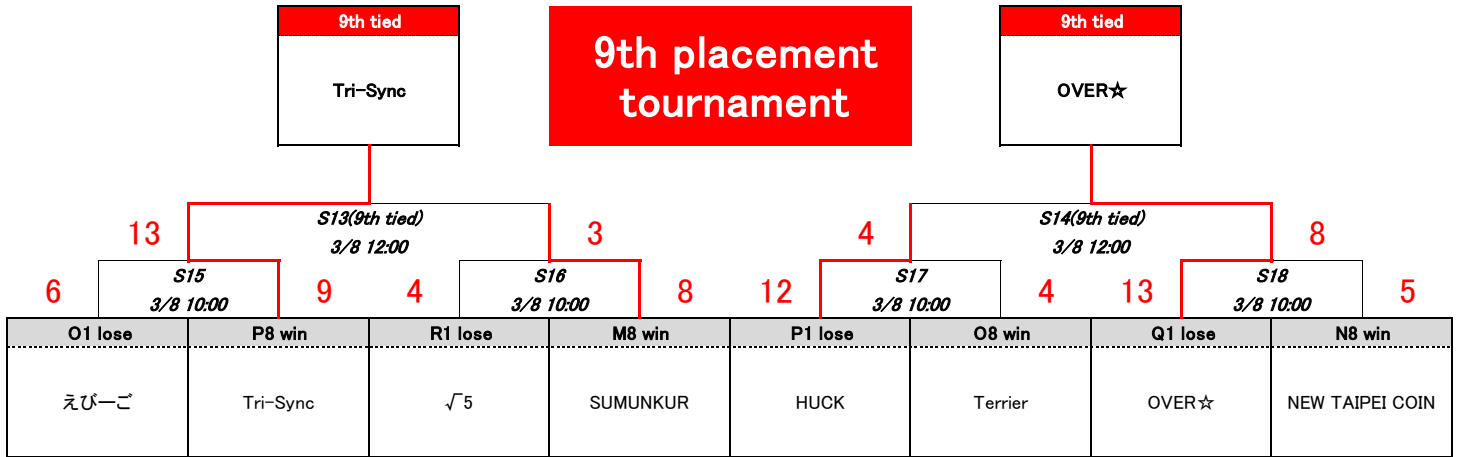

2026 CLUB Jr ULTIMATE DREAM CUP / WOMEN'S DIV.
Championship tournament

17th placement tournament

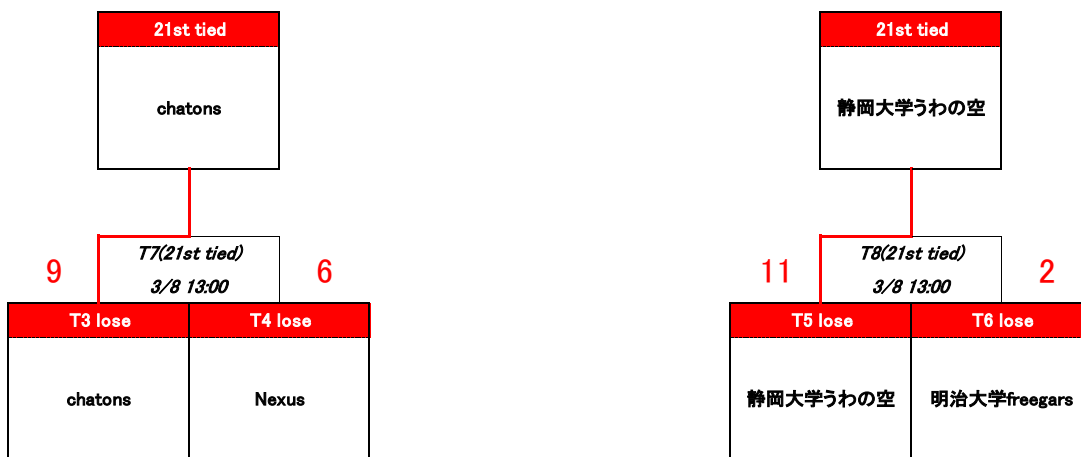
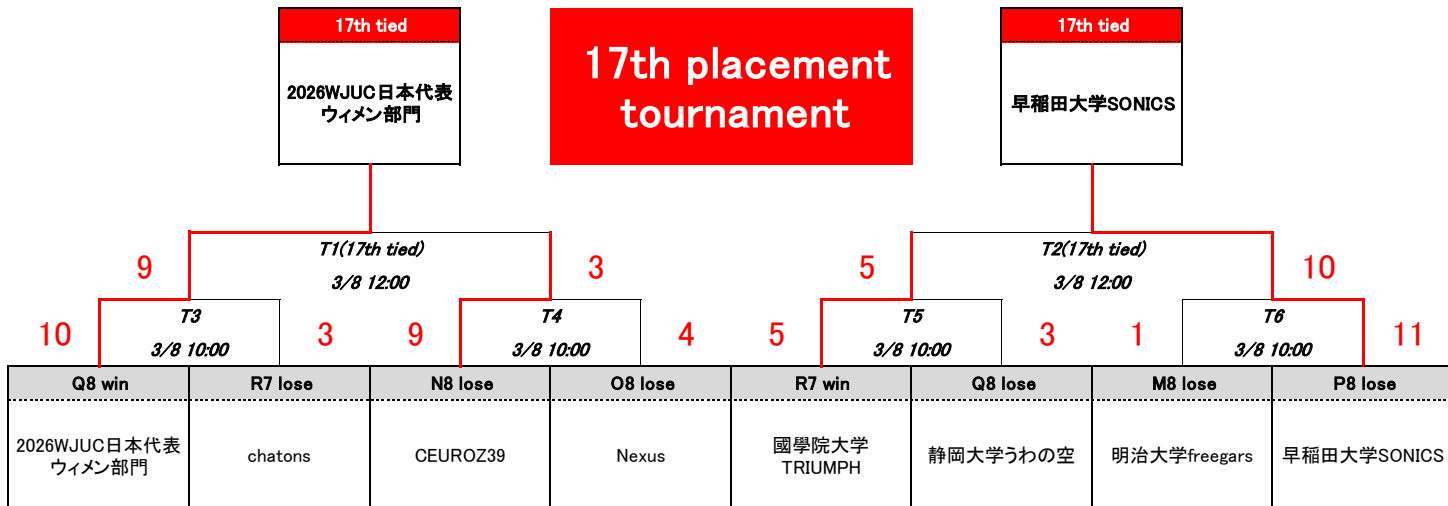

25th placement tournament

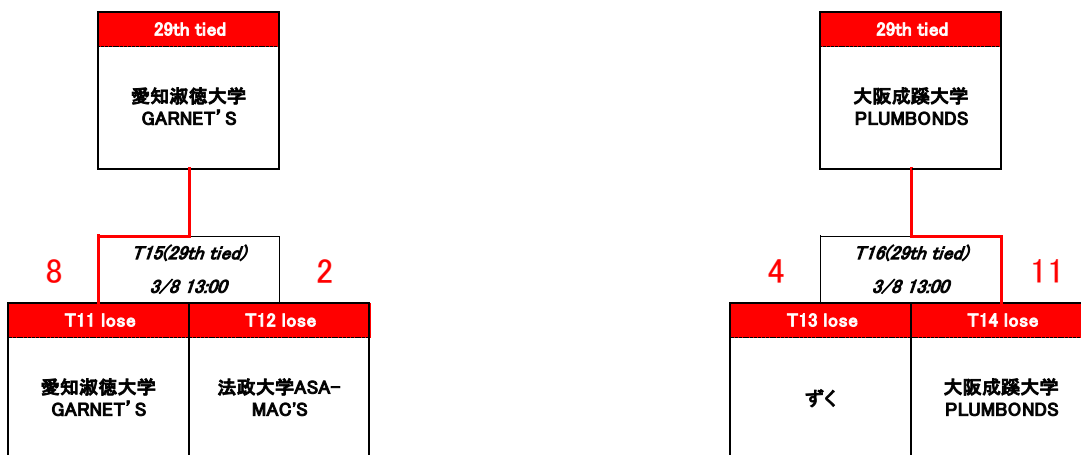
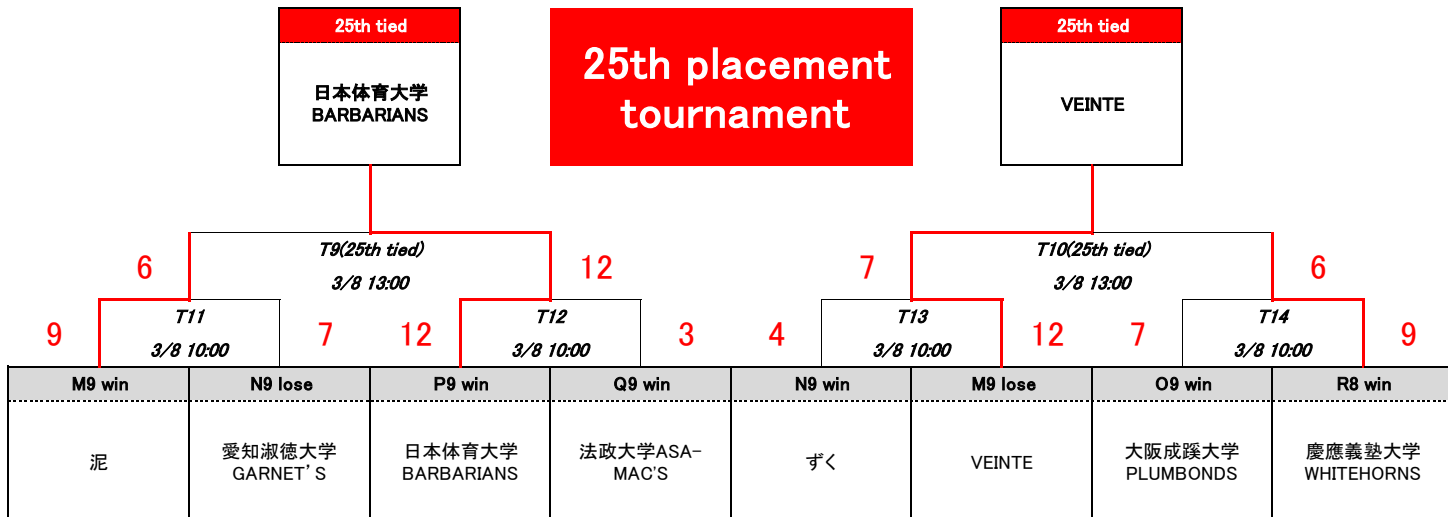

2026 CLUB Jr ULTIMATE DREAM CUP / WOMEN'S DIV.
Championship tournament

33rd placement
tournament

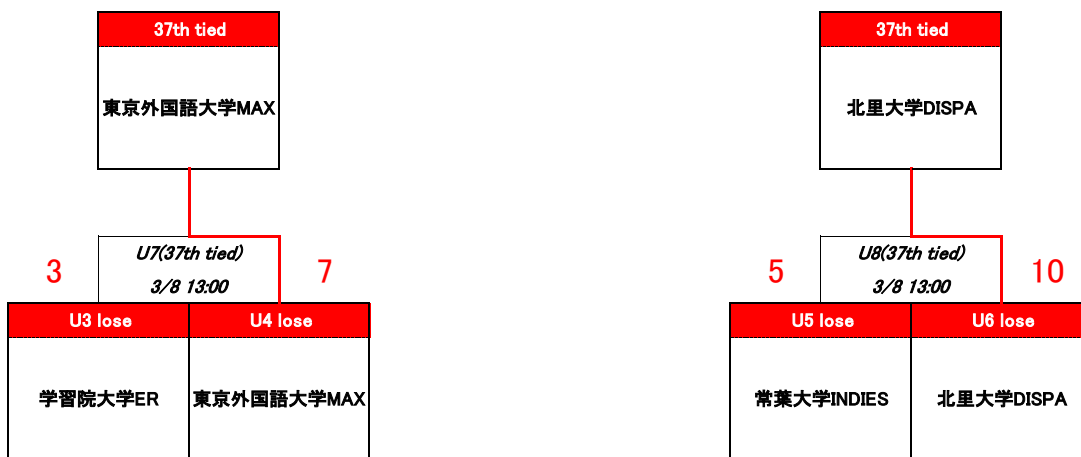
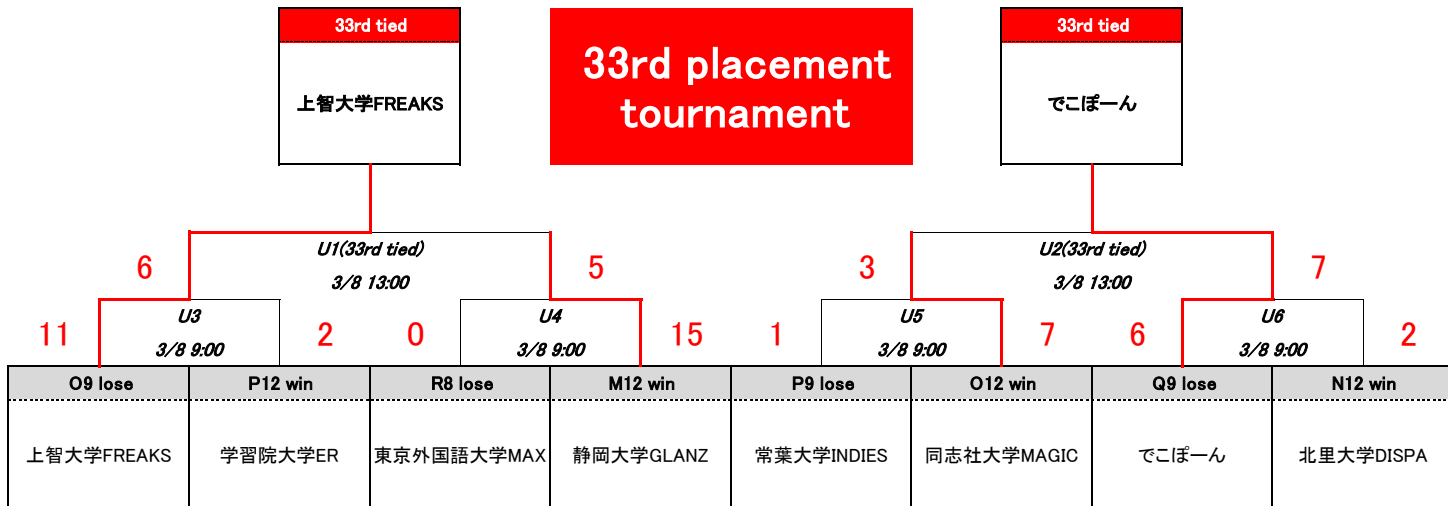

41st placement
tournament

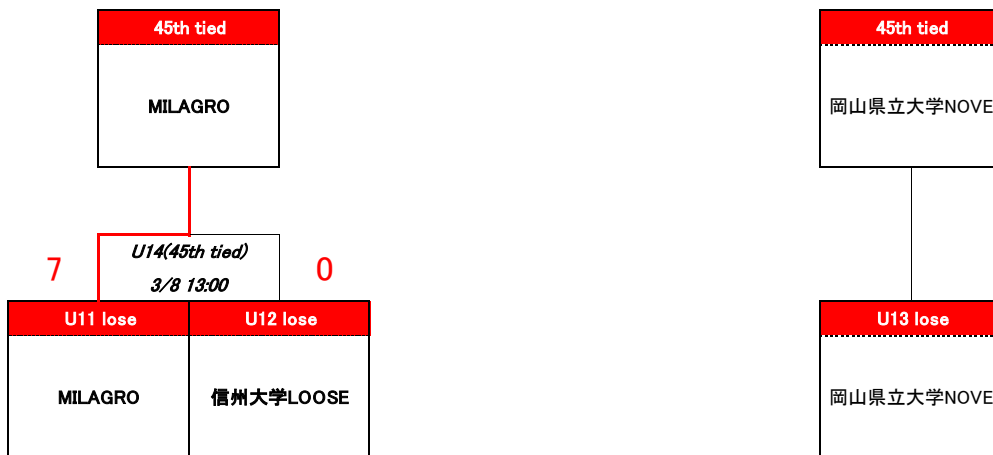
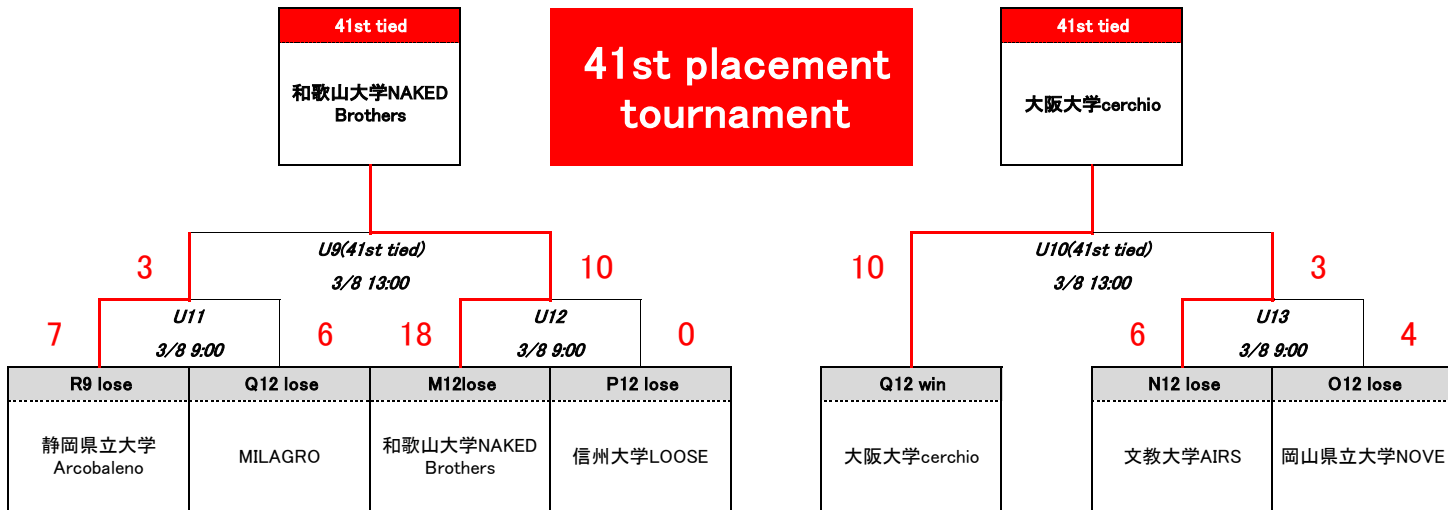

2026 CLUB Jr ULTIMATE DREAM CUP FINAL RESULT

OPEN DIV.

Rank	Team name	Rank	Team name	Rank	Team name	Rank	Team name
1st	文化シャッターBuzzBullets	17th	大阪スピリッツ	33rd	愛知淑徳大学GARNET'S	49th	常葉大学INDIES
2nd	Rascals		KURU		SORA		大阪体育大学Bouhsears
3rd	CLOWN	19th	Heat Haze	35th	上智大学フリース	51st	静岡大学GLANZ
4th	Technicolor		BOMBERS		國學院大學TRIUMPH		CREWS
5th	NomadicTribe	21st	Loquitos	37th	順天堂大学A'nemos	53rd	東北大学ALBATROSS
6th	2026WJUC日本代表オープン部門		大阪大学ENN		富士 龍神		東京理科大学CEU
7th	ゲッカーズ	23rd	Trigger	39th	chatons	55th	学習院大学ER
8th	OVERHEAT		和歌山大学NAKED Brothers		中京大学FLIPPERS		龍谷大学ROC-A-AIR
9th	Bustar	25th	日本体育大学BARBARIANS	41st	Tibets	57th	信州大学LOOSE
	SAMURAI		明治大学FreeFlyers		名古屋大学Blooms		DISCMANIA
11th	Pendants	27th	Hedgehog Ultimate	43rd	筑波大学INVERHOUSE	59th	九州大学NICK
	愛知大学NEXUS		関西学院大学ARROWS		RE:BOMBERS		京都大学BREEZE
13th	Silvana	29th	慶應義塾大学HUSKIES	45th	tequila sunroad	61st	Echo
	博多ハッカーズ		北海道大学PADDY		同志社大学Magic		静岡県立大学Arcobaleno
15th	早稲田大学SONICS	31st	MoM	47th	駒澤大学Milagro	63rd	静岡大学うわの空
	STILTS		IROHAS FD		岡山県立大学NOVE		YOSORA
Rank	Individual award						
MVP	古澤 隆憲 選手(文化シャッターBuzzBullets 所属)						
Fighting spirit award	倉知 健太 選手(Rascals 所属)						

WOMEN'S DIV.

Rank	Team name	Rank	Team name	Rank	Team name	Rank	Team name
1st	SWAMPYBARG	13th	えびーご	25th	日本体育大学BARBARIANS	37th	東京外国語大学MAX
2nd	MUD		Terrier		VEINTE		北里大学DISPA
3rd	壱	15th	√5	27th	泥	39th	学習院大学ER
4th	ORCA		NEW TAIPEI COIN		慶應義塾大学WHITEHORNS		常葉大学INDIES
5th	TOKYO MAVERICKS	17th	2026WJUC日本代表ウィメン部門	29th	愛知淑徳大学GARNET'S	41st	和歌山大学NAKED Brothers
6th	RadRise		早稲田大学SONICS		大阪成蹊大学PLUMBONDS		大阪大学cerchio
7th	Buddy's	19th	CEUROZ39	31st	法政大学ASA-MAC'S	43rd	静岡県立大学Arcobaleno
8th	中京大学Naughty Kids		國學院大學TRIUMPH		ずく		文教大学AIRS
9th	Tri-Sync	21st	chatons	33rd	上智大学FREAKS	45th	MILAGRO
	OVER☆		静岡大学うわの空		でこぼーん		岡山県立大学NOVE
11th	SUMUNKUR	23rd	Nexus	35th	静岡大学GLANZ	47th	信州大学LOOSE
	HUCK		明治大学freegars		同志社大学MAGIC		
Rank	Individual award						
MVP	曾我部 菜菜 選手(SWAMPYBARG 所属)						
Fighting spirit award	喜多 皓美 選手(MUD 所属)						